

# 424-000016

## 160x200 INSTALLATION GUIDE WITH STORAGE BOX

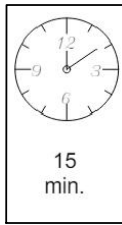

1

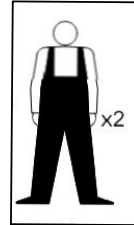
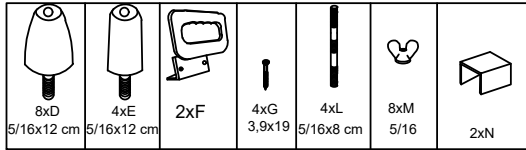
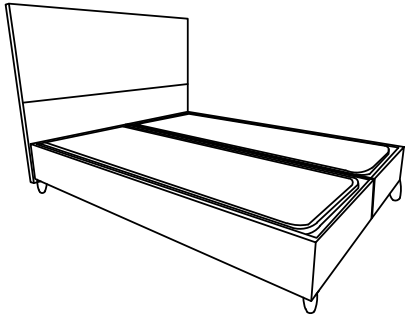
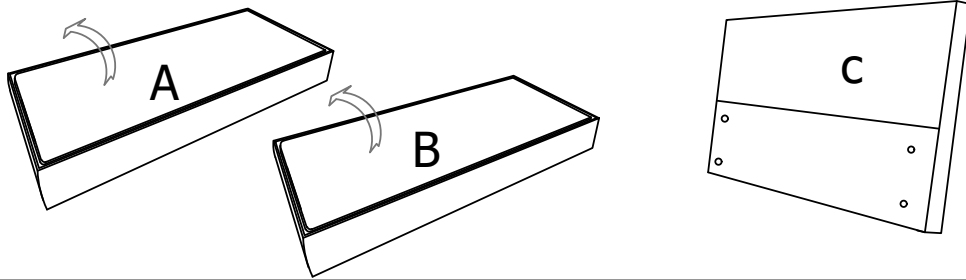

2

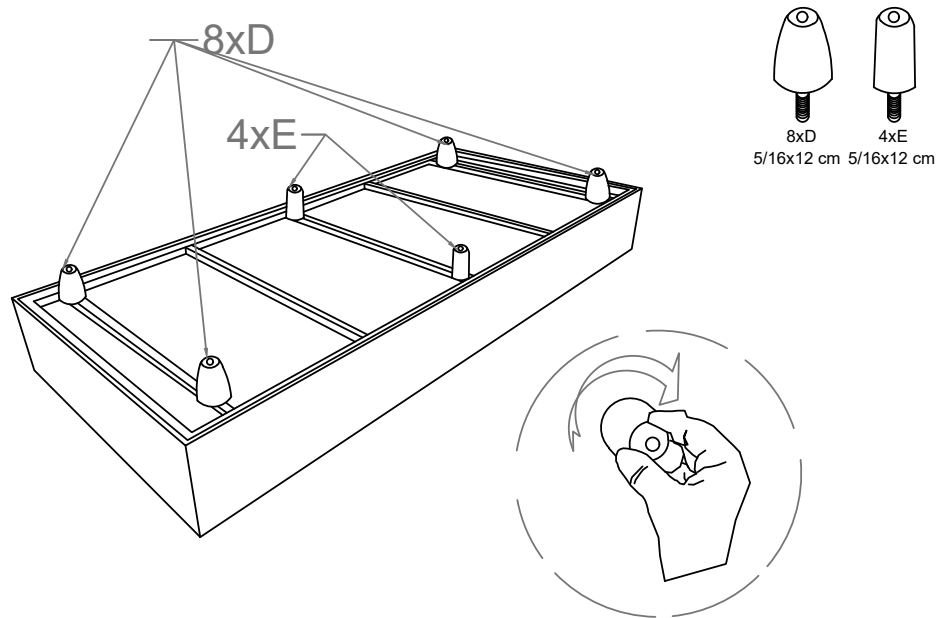

3

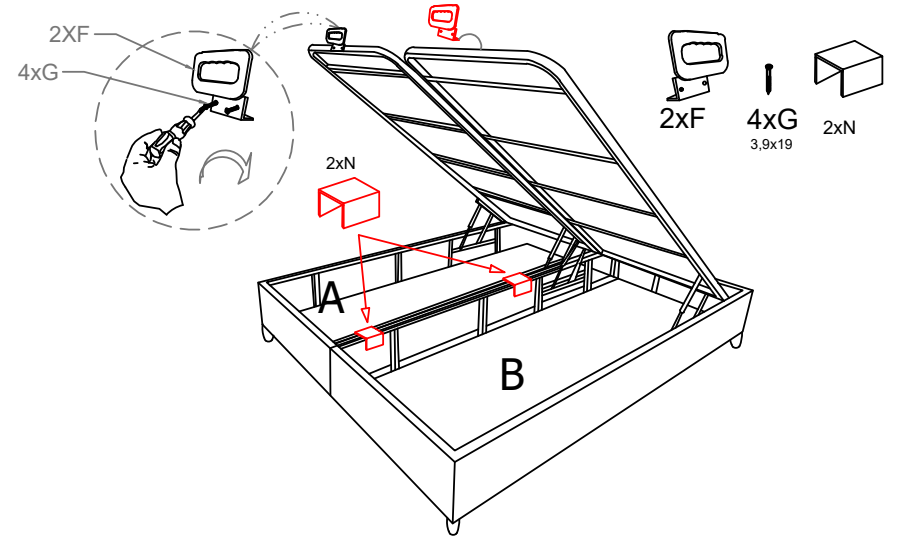

4

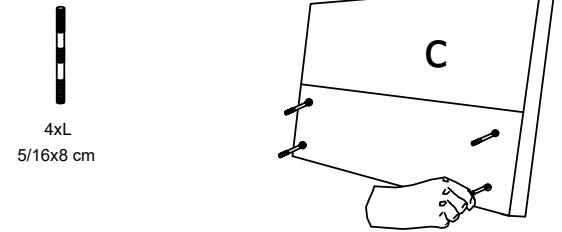

5

