

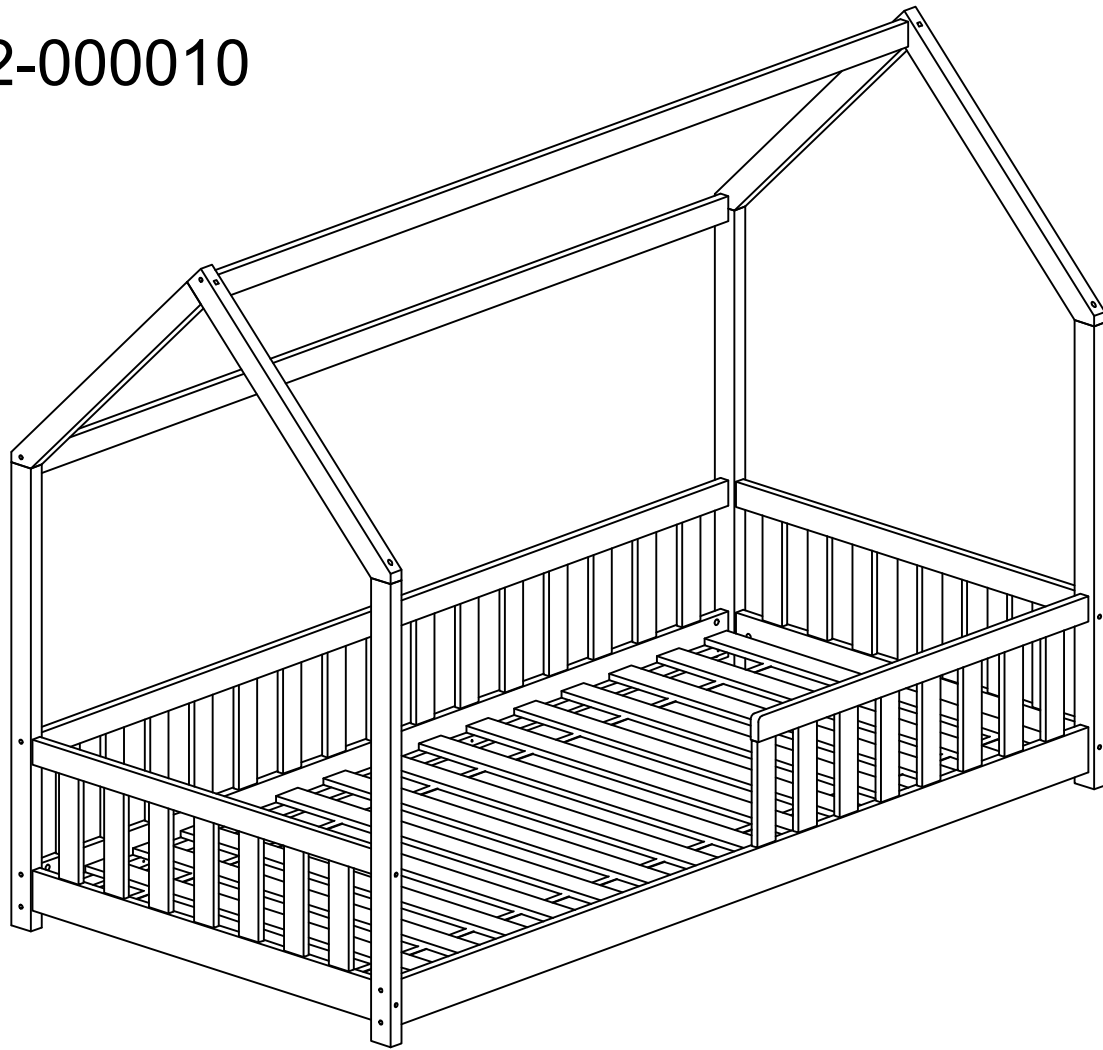



412-000010



A	 M6*70	x8
---	--	----

B		x12
---	---	-----

C	 Ø8*30	x29
---	--	-----

D	 Ø6*70	x11
---	--	-----

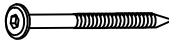
E	 Ø6*90	x6
---	--	----

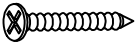
F	 Ø4*30	x30
---	--	-----



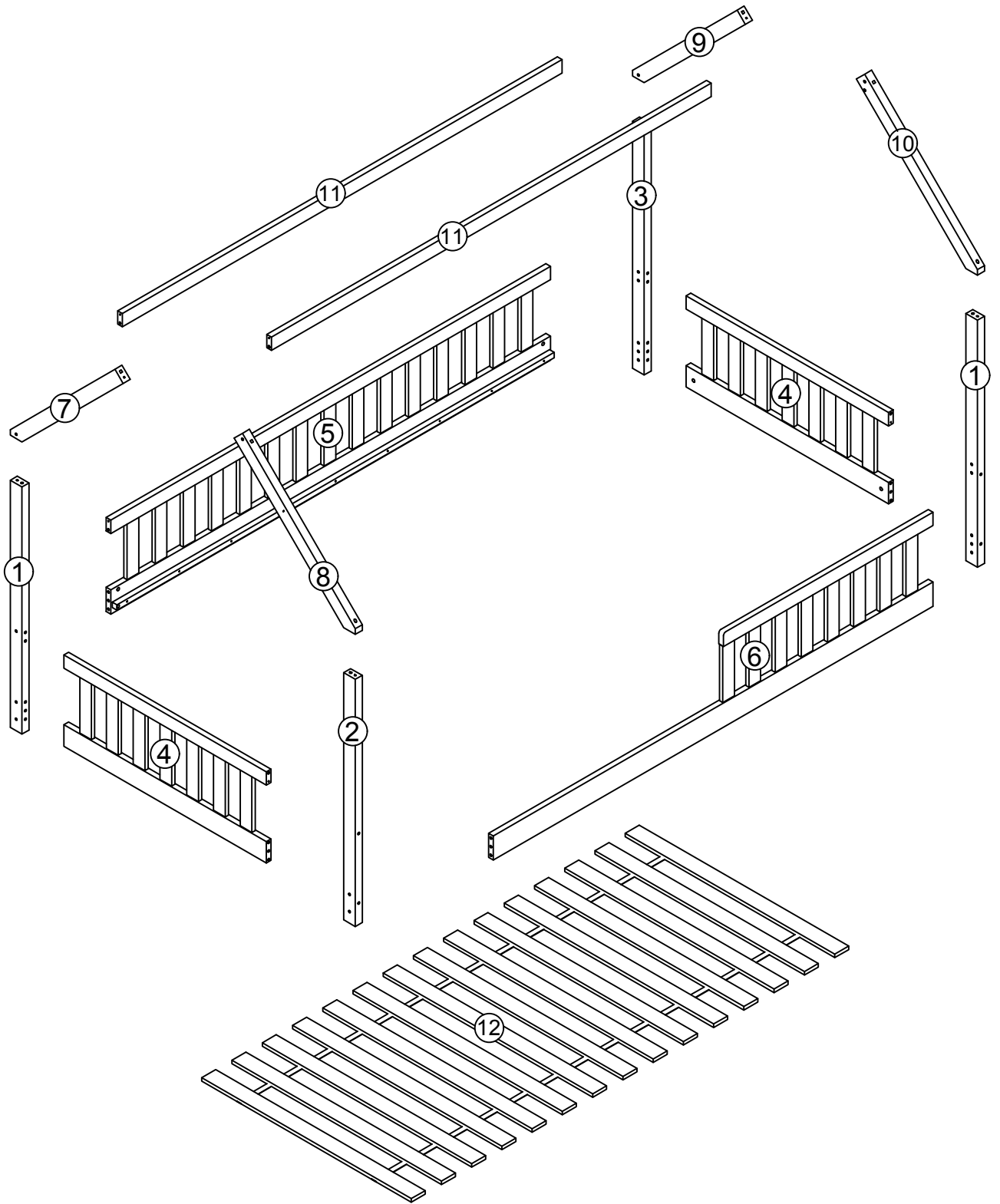

G	 M6*90	x4
---	--	----

H		x4
---	---	----

J		x1
---	---	----





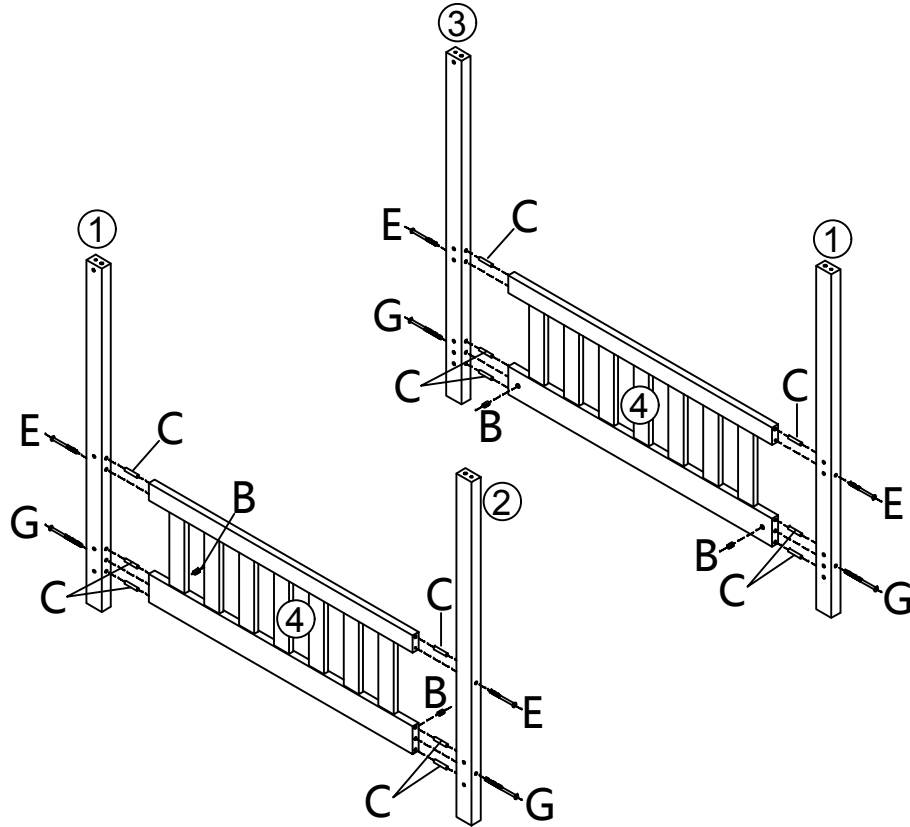

1

E x 4  Ø6*90	B x 4 	C x 12  Ø8*30	G x 4  M6*90	
---	--	---	---	---



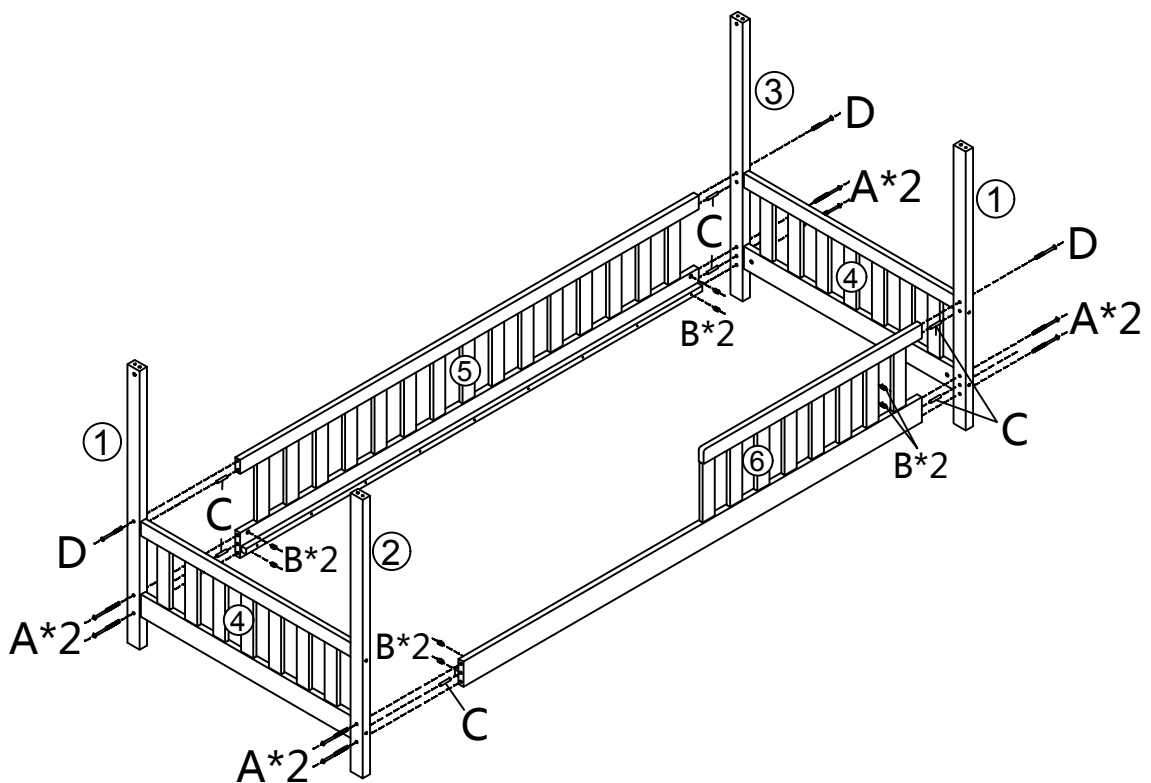

2

D x 3  Ø6*70	B x 8 	C x 7  Ø8*30	A x 8  M6*70	
---	--	--	---	---



3

<p>C x 2</p>  <p>Ø8*30</p>	<p>E x 2</p>  <p>Ø6*90</p>	
---	---	--

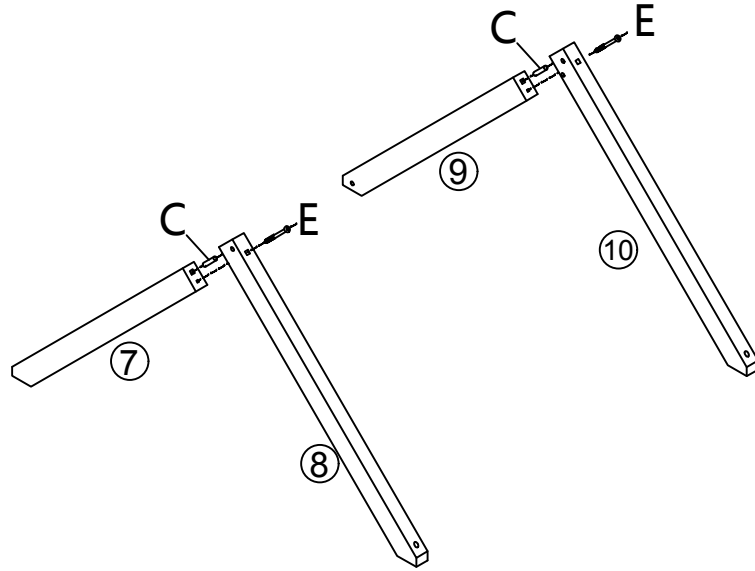

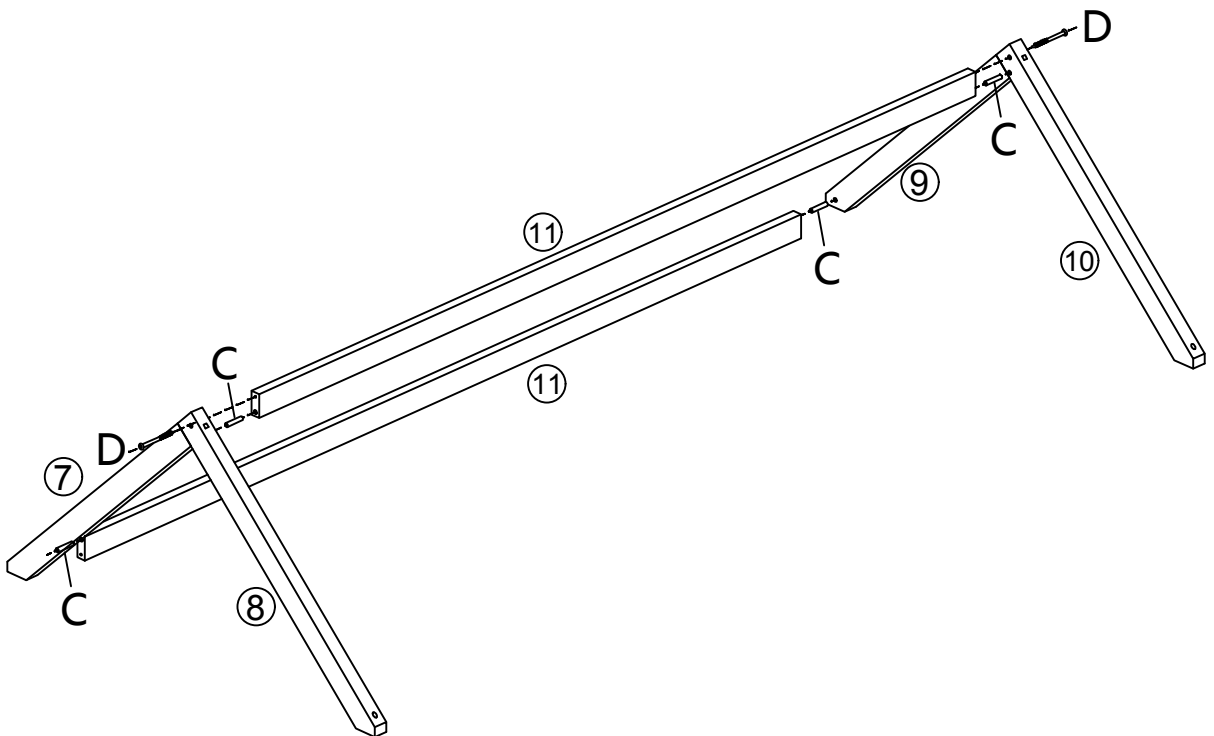

4

<p>D x 2</p>  <p>Ø6*70</p>	<p>C x 4</p>  <p>Ø8*30</p>	
---	---	--



5

D x 4  Ø6*70	C x 4  Ø8*30	
---	---	--

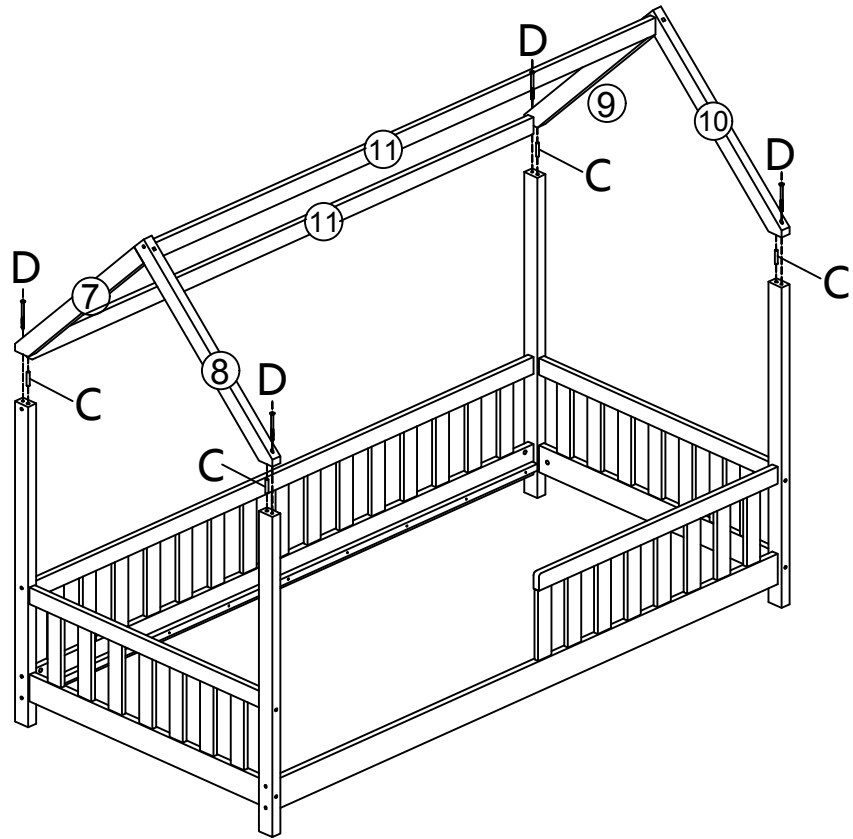

6

D x 2  Ø6*70	
---	--

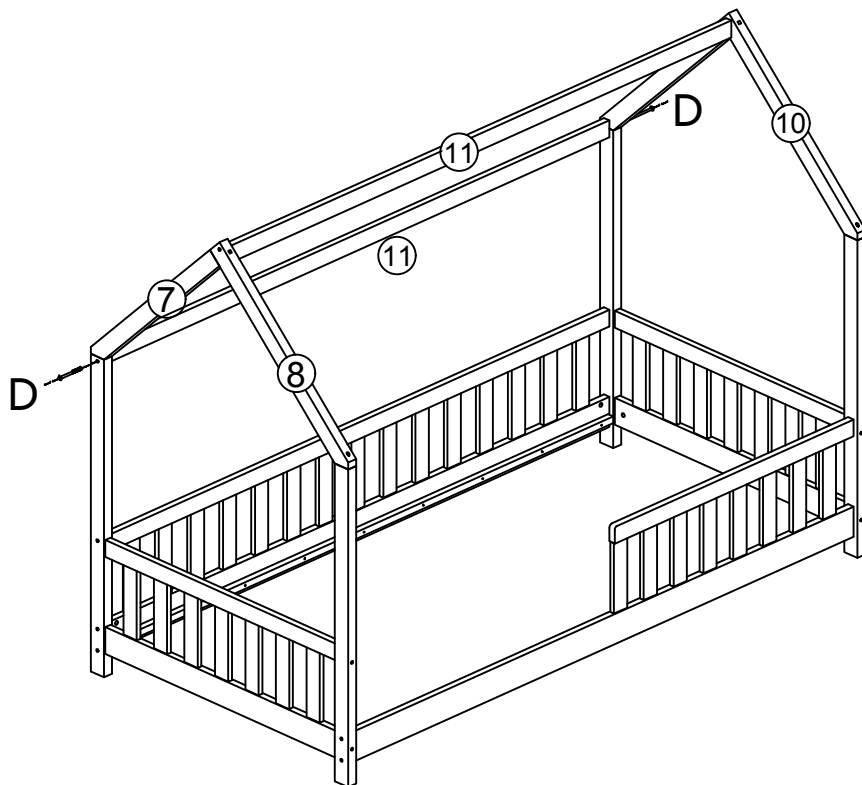

7

F x 30

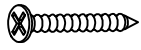

Ø4*30

H x 4

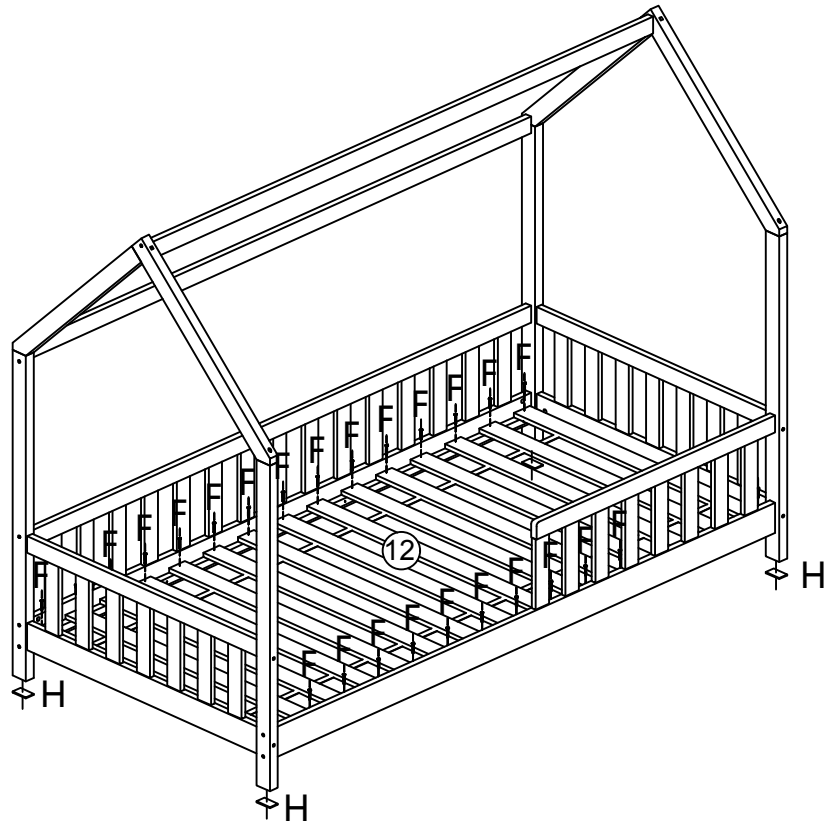
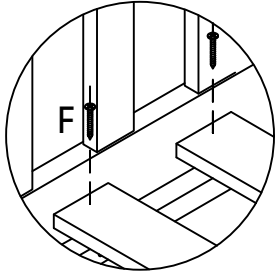
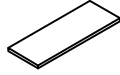

8

