

ASSEMBLY INSTRUCTIONS













SHOE CABINET FOR 6 PAIRS OF SHOES SOUKEN PAKOWORLD IN SONOMA-WHITE 383-000215



IMPORTANT

PLEASE READ BEFORE YOU CONTINUE FURTHER

1. MATERIAL USE LAMINATED PARTICLE BOARD, TO CLEAN USE SOFT, DRY CLOTH.
2. DO NOT USE DETERGENT OR CHEMICAL AVOID CONTACT WITH WATER AND DIRECT SUNLIGHT.
3. TO BE ASSEMBLED ON A SOFT, DRY, CLEAN SMOOTH SURFACE.
4. DO NOT USE ANY TOOLS OTHER THAN THOSE SHOWN.
5. USE OF POWER TOOLS TO ASSEMBLE THIS PRODUCT WILL INVALIDATE ANY CLAIM AND MAY DAMAGE THIS PRODUCT MAKING IT UNSAFE.
6. BEFORE STARTING ASSEMBLY PLEASE VERIFY IF ALL PARTS AND HARDWARE ARE INCLUDED.

HARDWARE LIST			QTY (pcs)
DH5		Soft Closing Hinges 5/8	4 Sets
DR2		Door Stopper	1
DW4		Wood Dowel 6 x 25mm	16
HD26		Plastic Bar Handle 96mm	2
LG1		Leg Pin	4
MF2		Nail	20 (+3)
MN2		Mini Fix 15mm	4 Sets
PF11		Small L Bracket	2
SC3		Screw M3.5 x 14mm	28
SC11		Screw M4 x 25mm	4
SC25		FH Screw M5 x 40mm	8
SH4		Plastic Shelf Support with Steel Pin	8

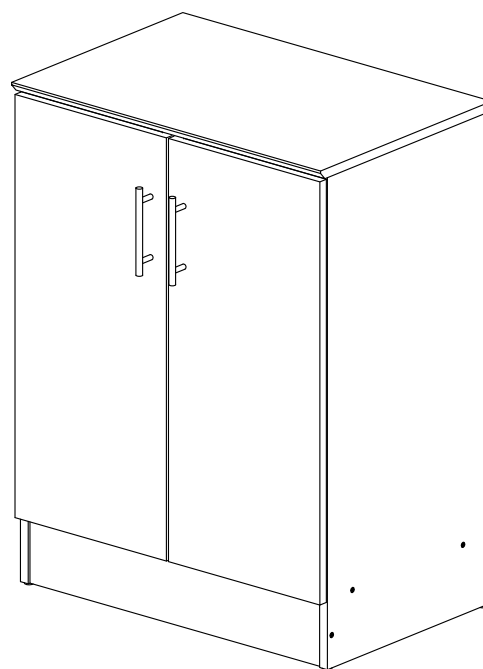

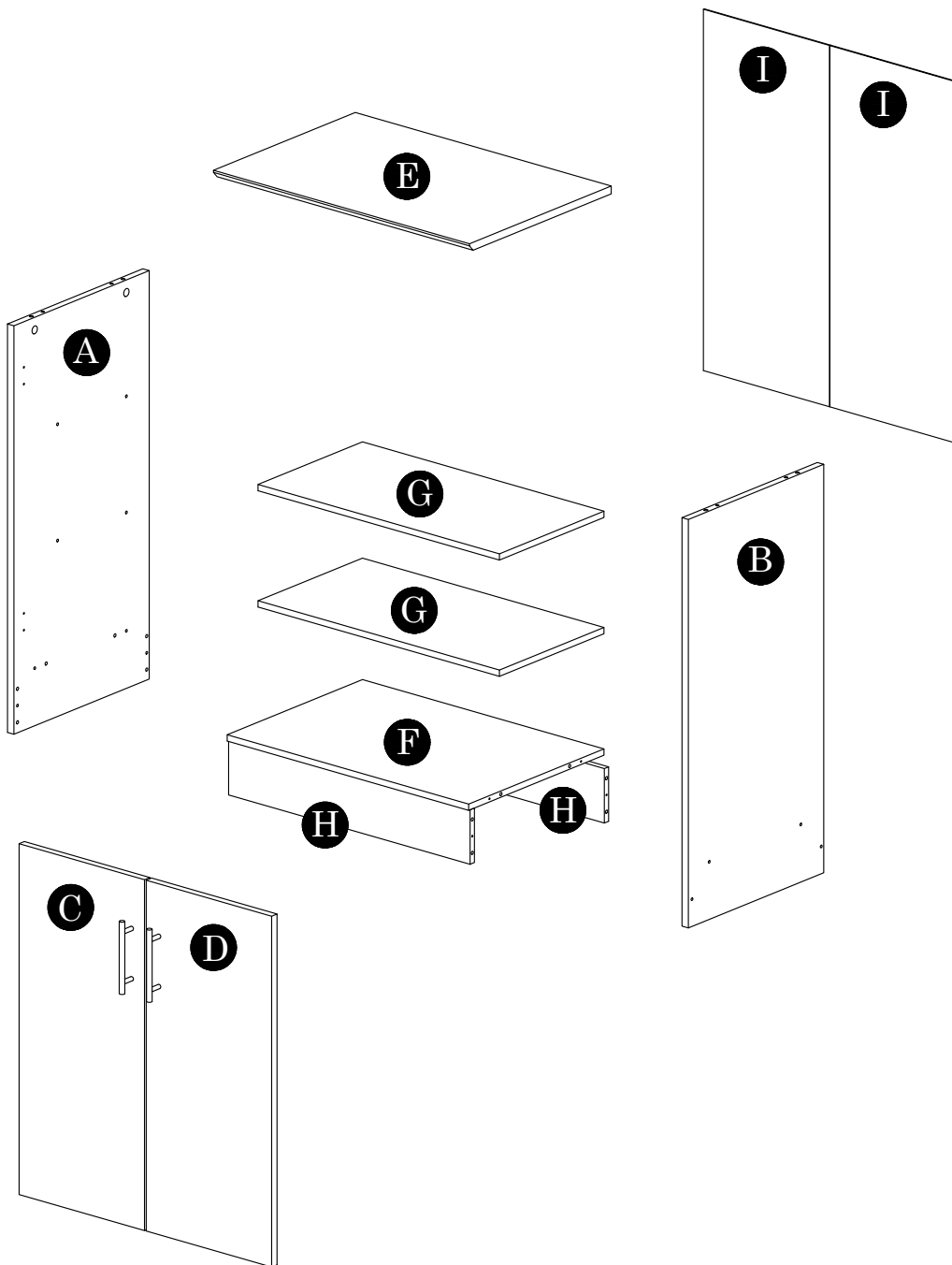

Parts List		QTY
A	Side Panel (L)	1 pc
B	Side Panel (R)	1 pc
C	Door Panel (L)	1 pc
D	Door Panel (R)	1 pc
E	Top Panel	1 pc
F	Bottom Panel	1 pc
G	Free Shelf Panel	2 pcs
H	Bottom Crossbar	2 pcs
I	Backboard	2 pcs



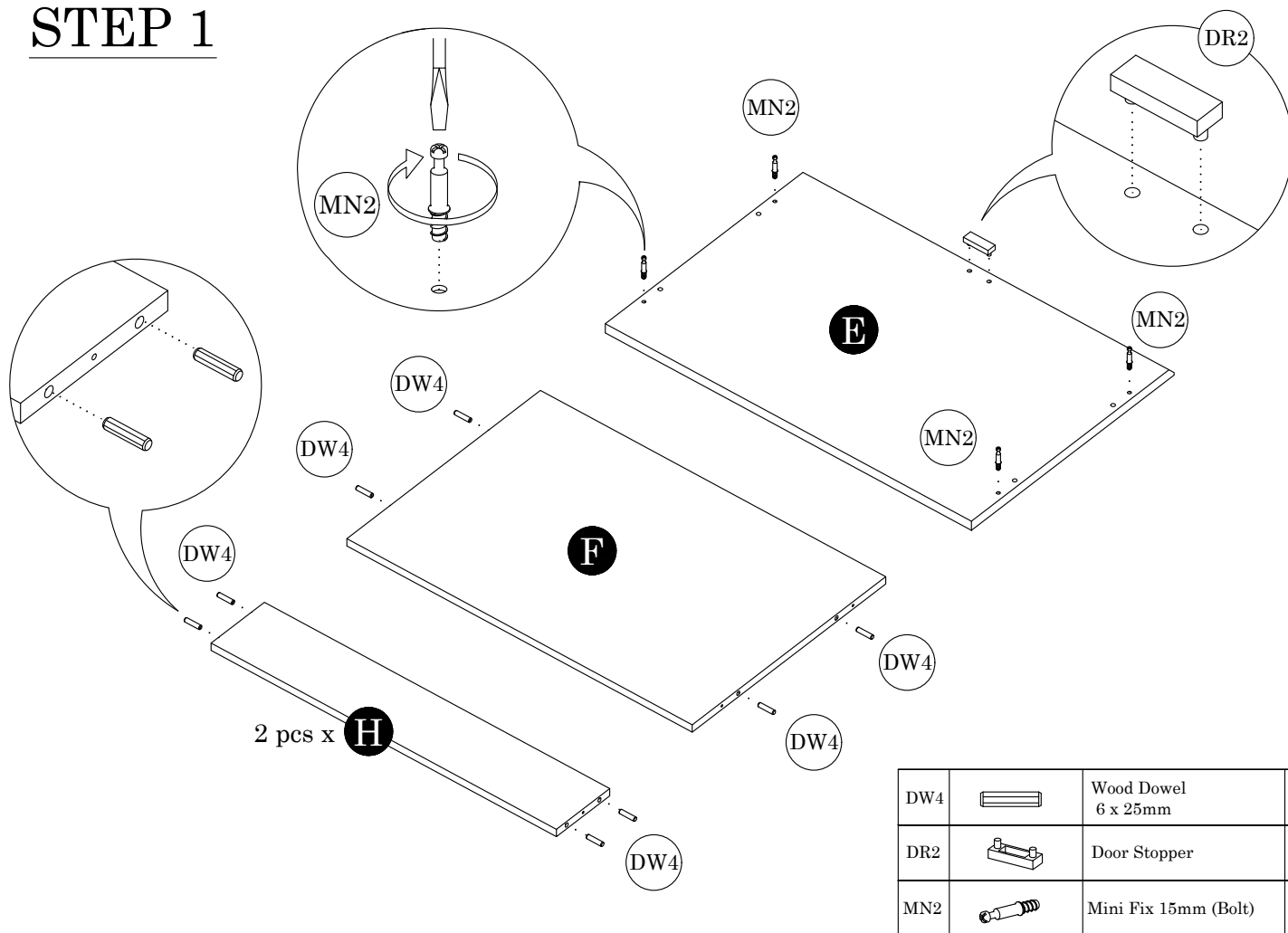

STEP 1



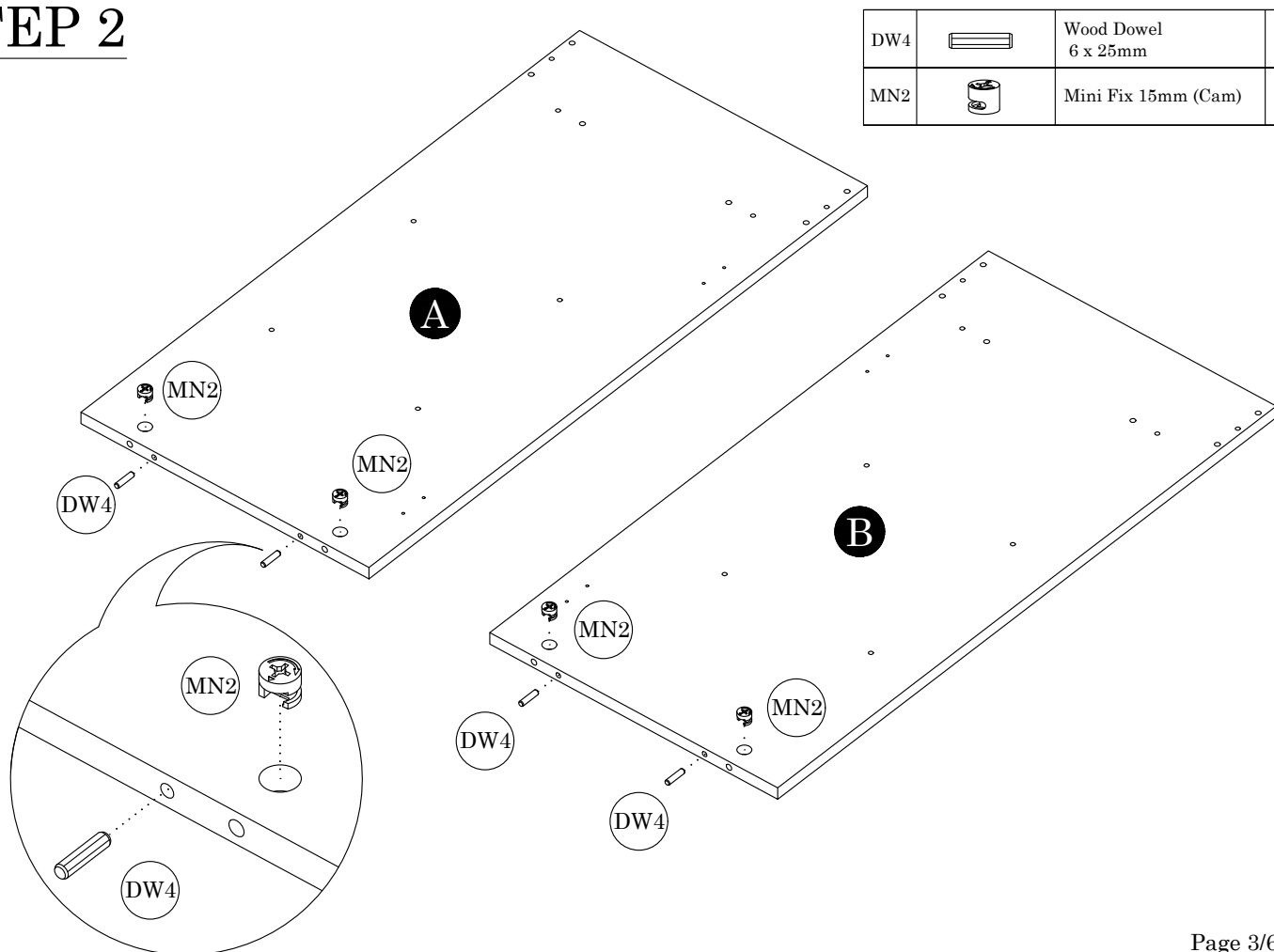

DW4		Wood Dowel 6 x 25mm	12
DR2		Door Stopper	1
MN2		Mini Fix 15mm (Bolt)	4

STEP 2



DW4		Wood Dowel 6 x 25mm	4
MN2		Mini Fix 15mm (Cam)	4

STEP 3

DH5		Soft Closing Hinges 5/8	4 Sets
SC3		Screw M3.5mm x 14mm	8

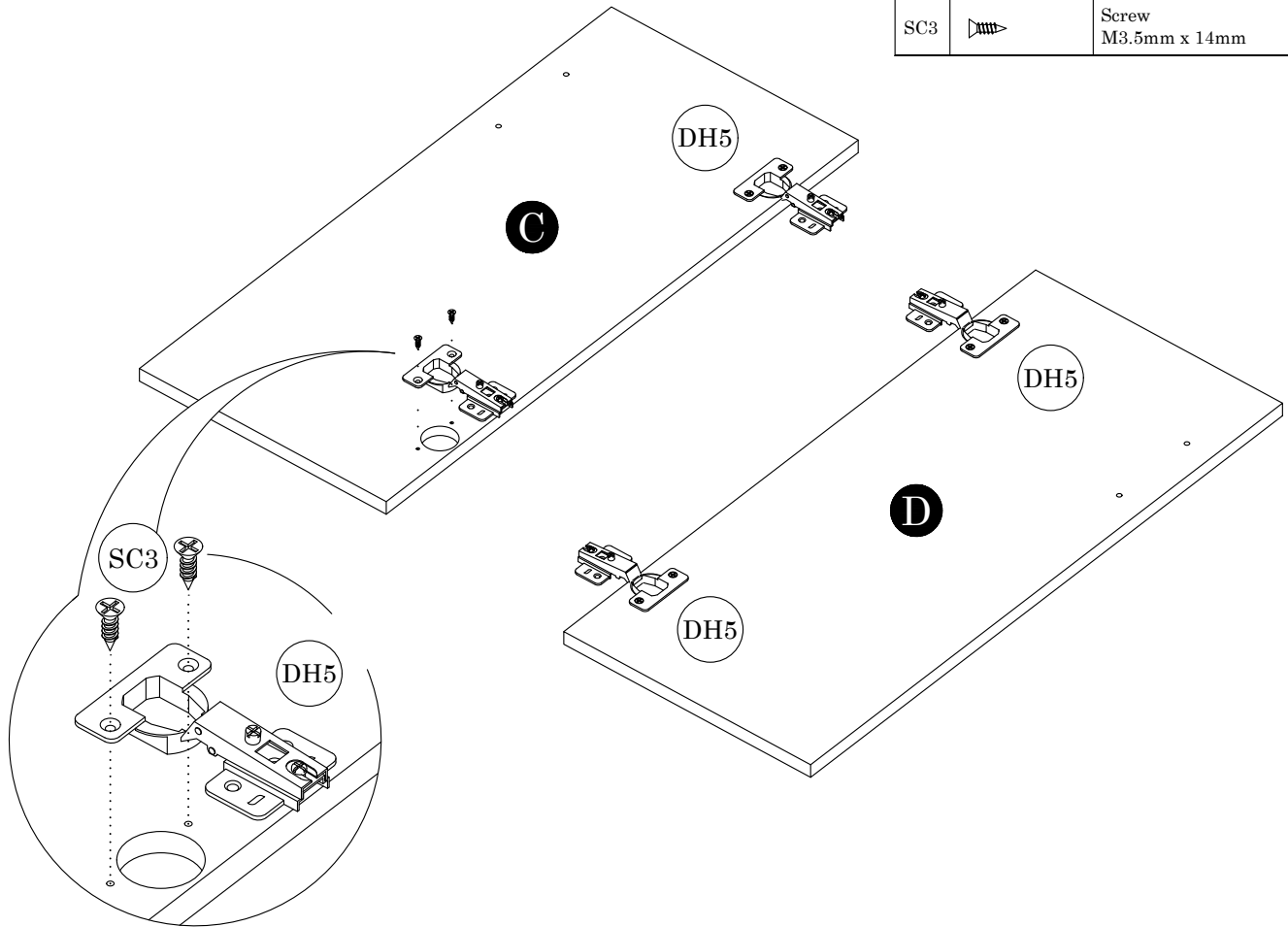

STEP 4

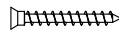
SC25		FH Screw M5 x 40mm	8
------	---	-----------------------	---

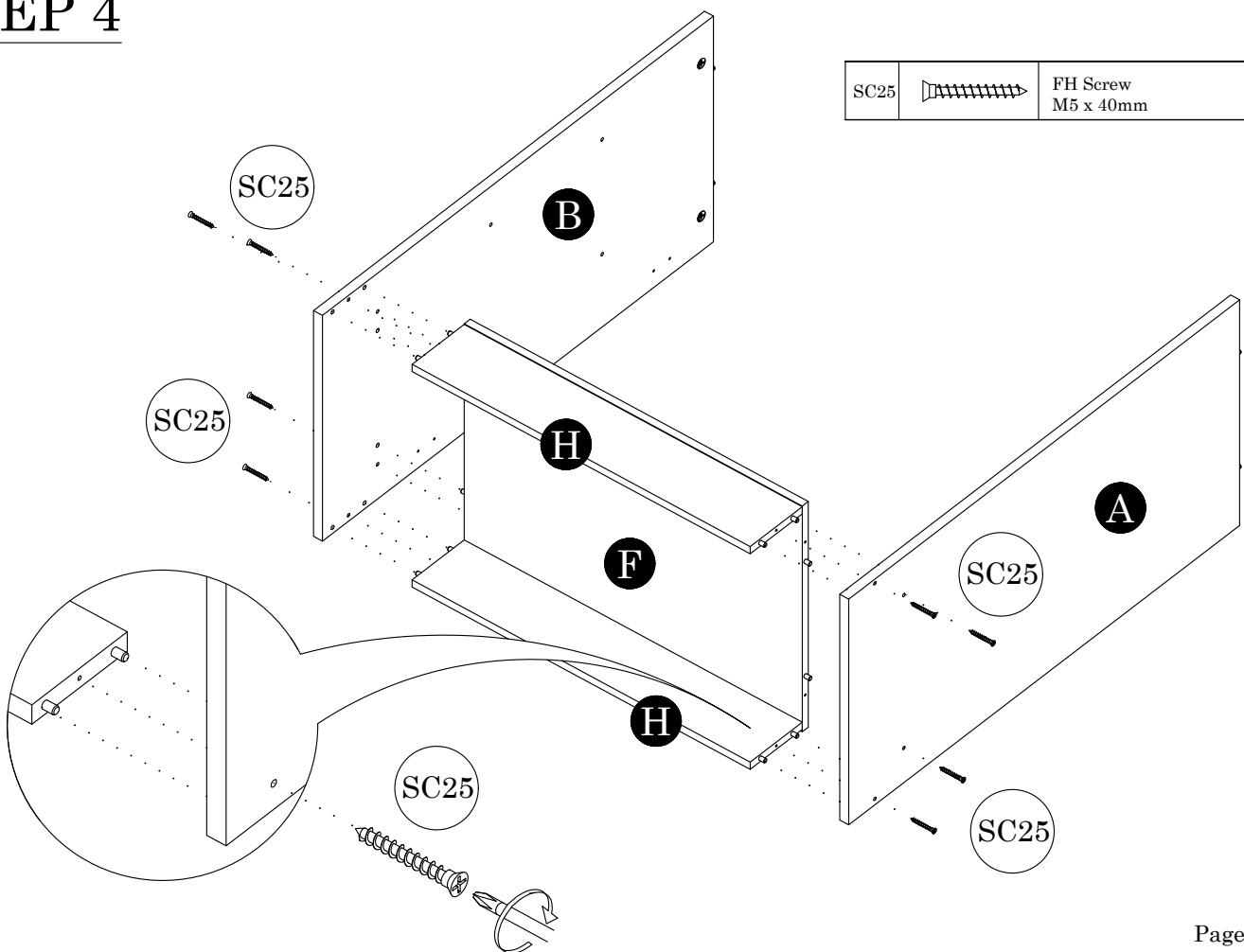

STEP 5

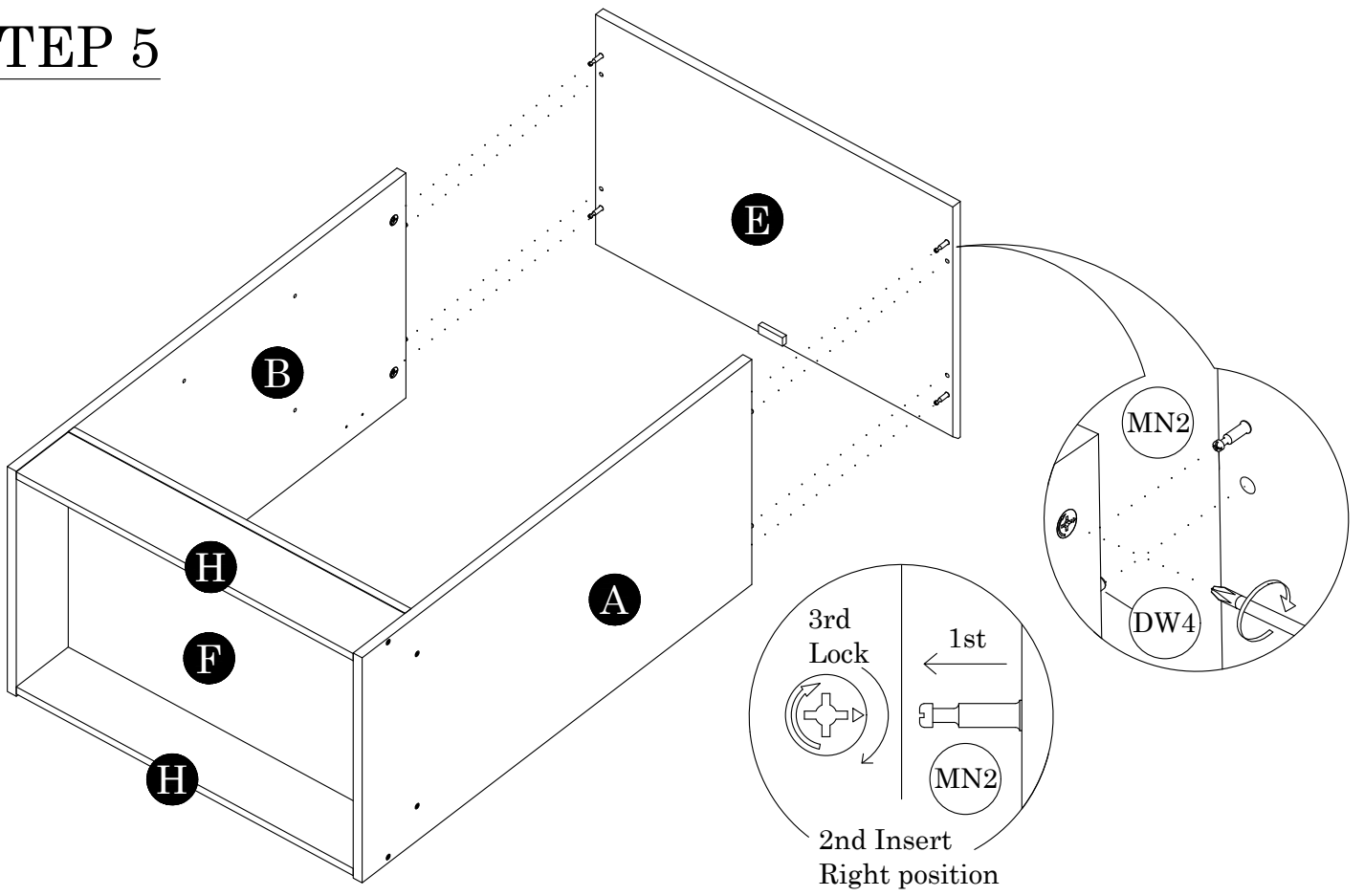

STEP 6

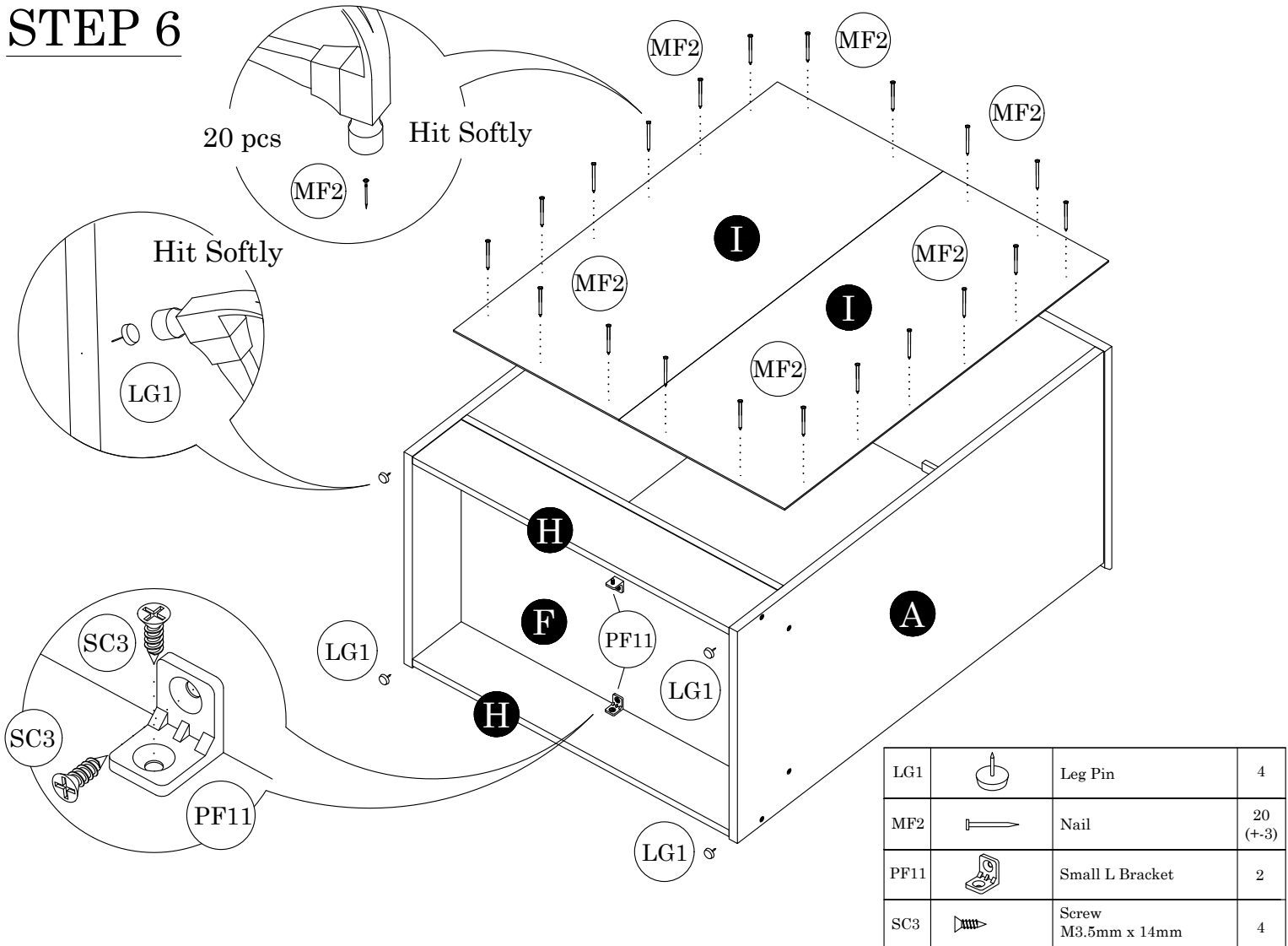

LG1		Leg Pin	4
MF2		Nail	20 (+-3)
PF11		Small L Bracket	2
SC3		Screw M3.5mm x 14mm	4

STEP 7

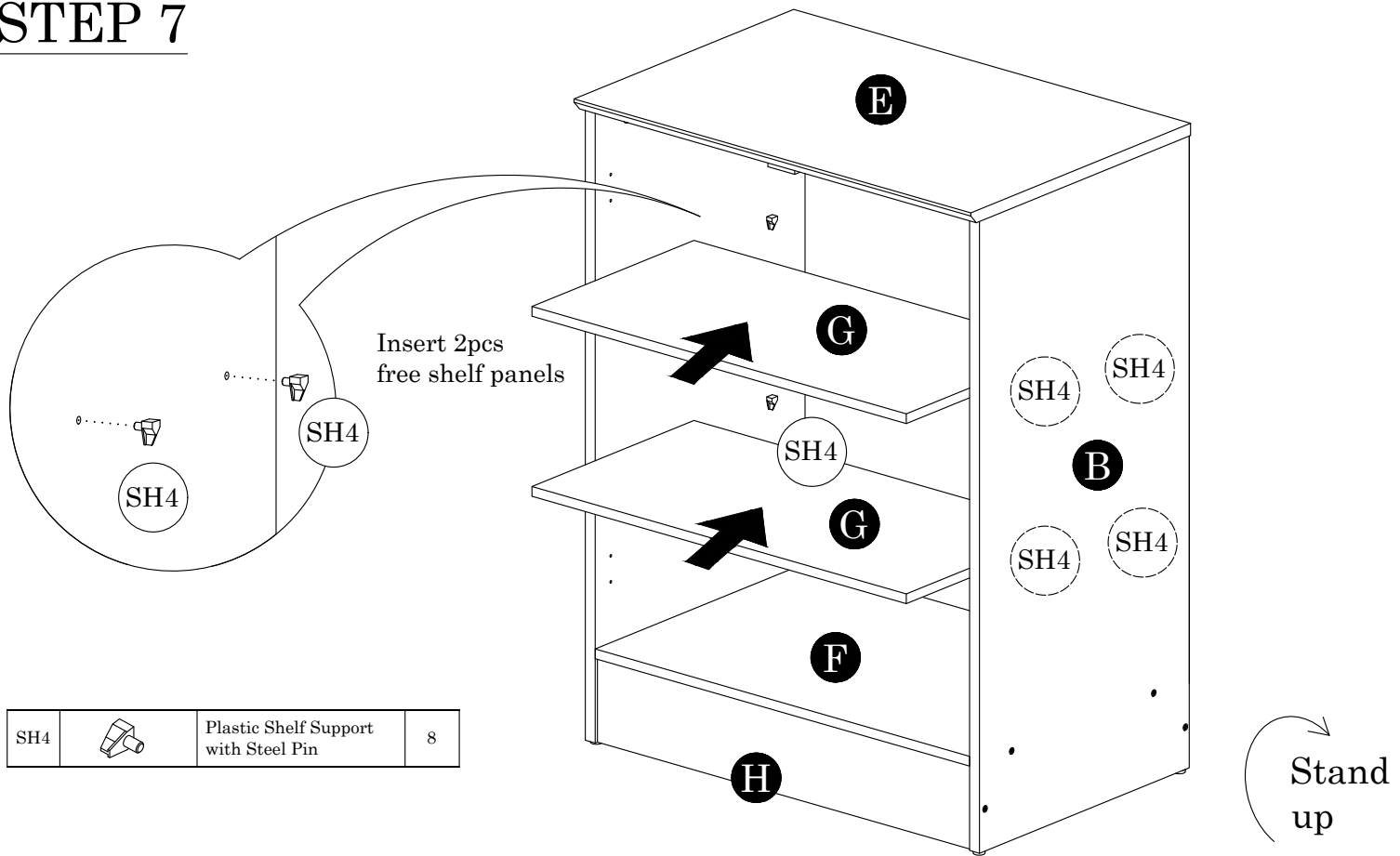

STEP 8

