

ASSEMBLY INSTRUCTIONS

383-000044



IMPORTANT

PLEASE READ BEFORE YOU CONTINUE FURTHER

1. MATERIAL USE LAMINATED PARTICLE BOARD, TO CLEAN USE SOFT, DRY CLOTH.
2. DO NOT USE DETERGENT OR CHEMICAL AVOID CONTACT WITH WATER AND DIRECT SUNLIGHT.
3. TO BE ASSEMBLED ON A SOFT, DRY, CLEAN SMOOTH SURFACE.
4. DO NOT USE ANY TOOLS OTHER THAN THOSE SHOWN.
5. USE OF POWER TOOLS TO ASSEMBLE THIS PRODUCT WILL INVALIDATE ANY CLAIM AND MAY DAMAGE THIS PRODUCT MAKING IT UNSAFE.
6. BEFORE STARTING ASSEMBLY PLEASE VERIFY IF ALL PARTS AND HARDWARE ARE INCLUDED.

HARDWARE LIST			QTY (pcs)
DH5		Soft Closing Hinges 5/8	4 Sets
DW4		Wood Dowel 6 x 25mm	40
HD6		Plastic Handle 128mm	4
HSP30		Hanging Steel Pipe 19mm x 769mm	1
LG1		Leg Pin	4
MF2		Nail	55 (+3)
MN2		Mini Fix 15mm	4 Sets
PF2		Single Plastic Cap	8
PF11		Small L Bracket	1
SC3		Screw M3.5 x 14mm	70
SC13		Screw M4 x 30mm	8
SC18		Screw M4 x 38mm	8
SC25		FH Screw M5 x 40mm	14
SK2		Round Sticker	14
SL5		Drawer Metal Slide 300mm	2 Sets

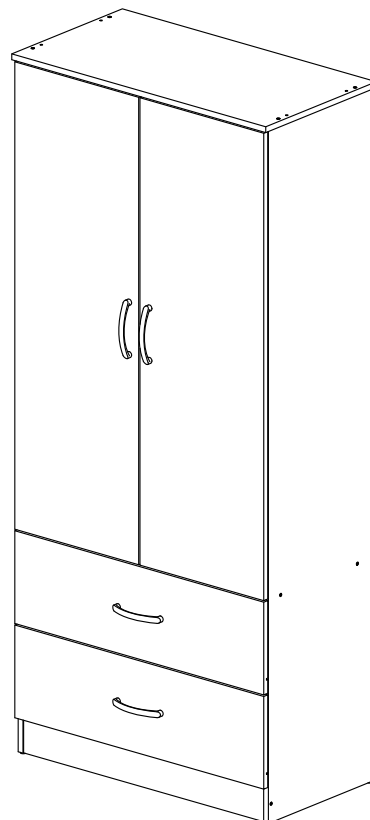

Parts List		QTY
A	Top Panel	1 pc
B	Side Panel (L)	1 pc
C	Side Panel (R)	1 pc
D	Door Panel	2 pcs
E	Drawer Front Panel	2 pcs
F	Drawer Side Panel (L)	2 pcs
G	Drawer Side Panel (R)	2 pcs
H	Shelf Panel	1 pc
I	Bottom Crossbar	2 pcs
J	Small Crossbar	1 pc
K	Drawer Back Board	2 pcs
L	Drawer Crossbar	2 pcs
M	Top Crossbar	1 pc
N	Backboard	2 pcs
O	Drawer Bottom Panel	2 pcs

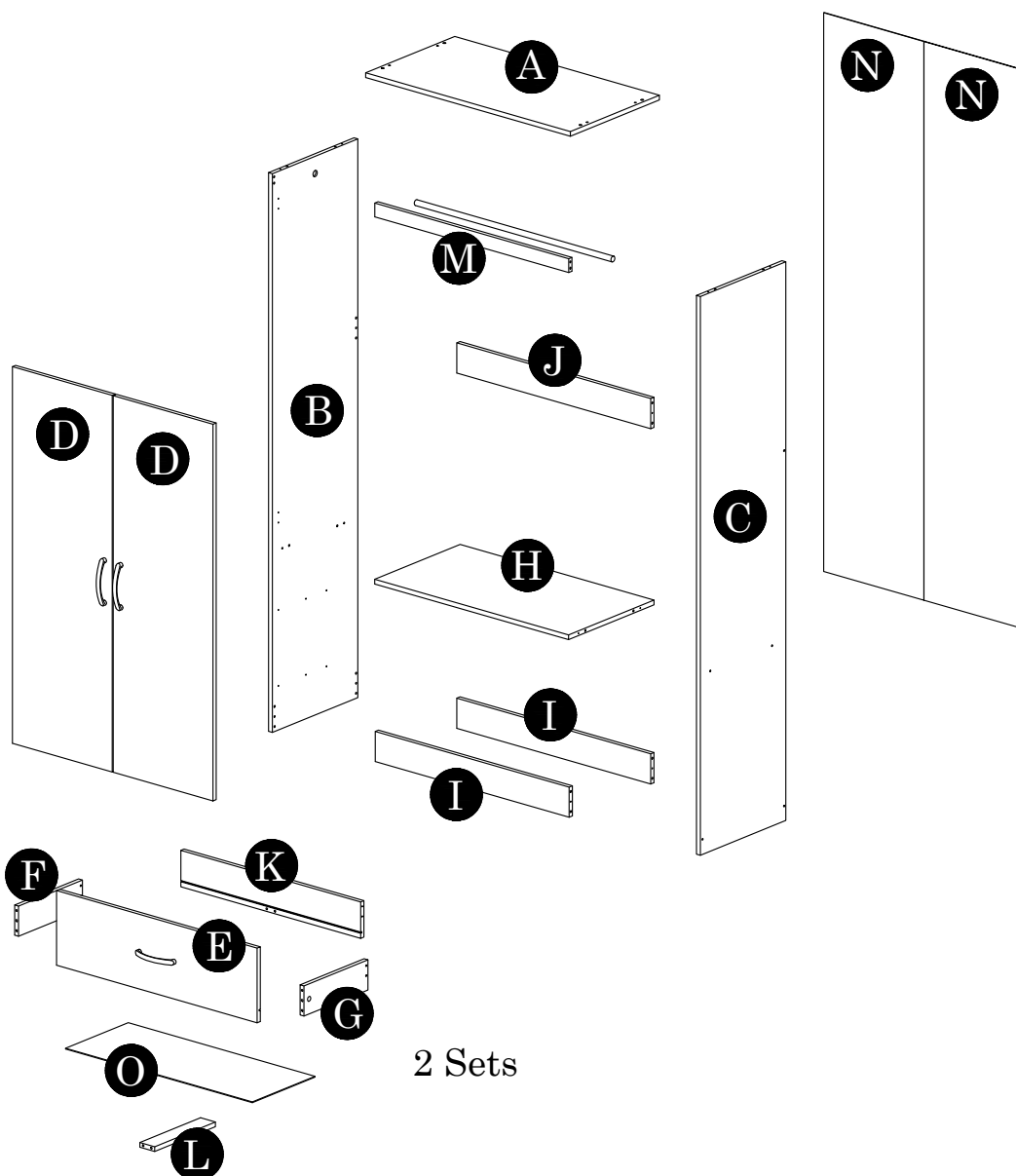

STEP 1

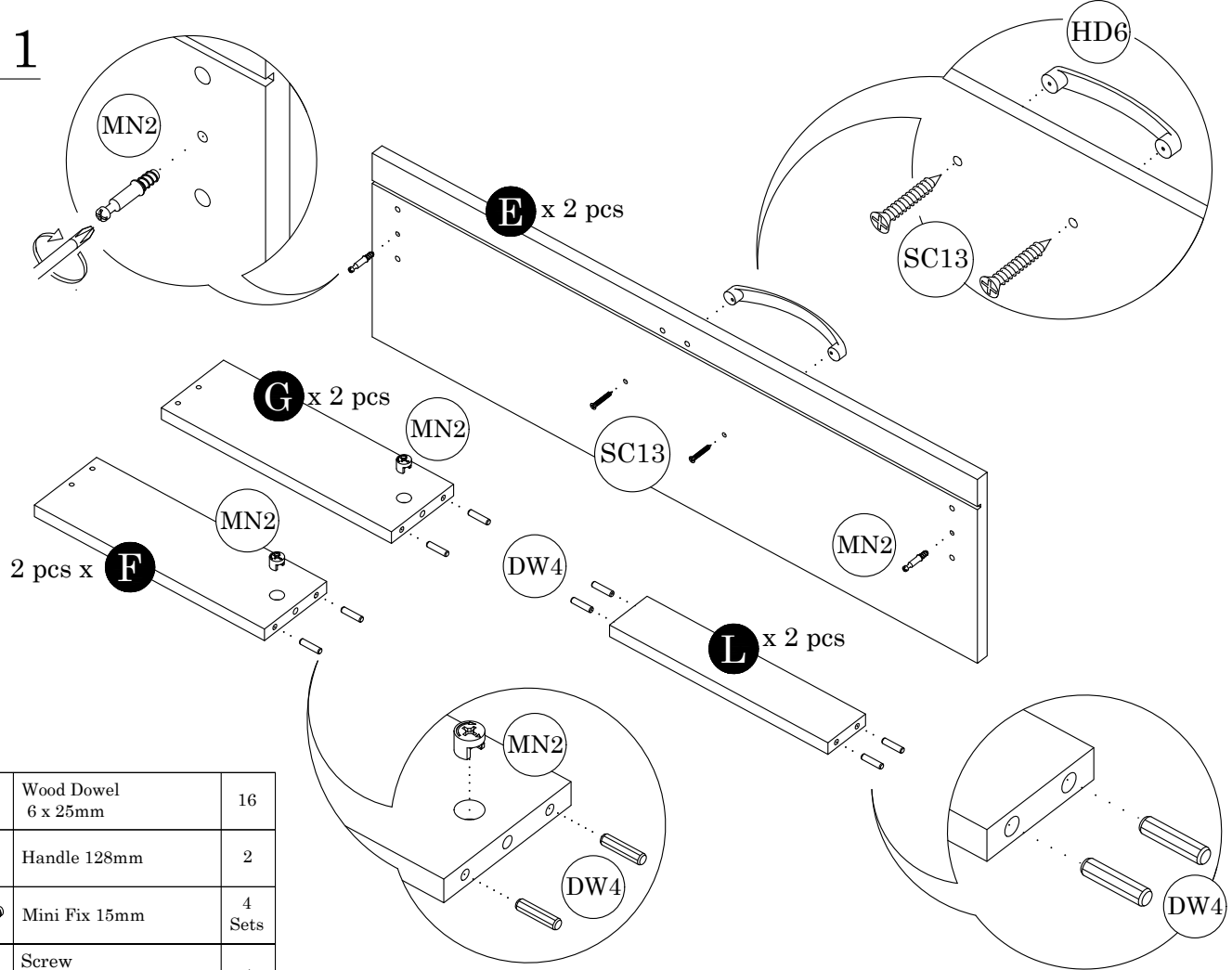

DW4		Wood Dowel 6 x 25mm	16
HD6		Handle 128mm	2
MN2		Mini Fix 15mm	4 Sets
SC13		Screw M4 x 30mm	4

STEP 2

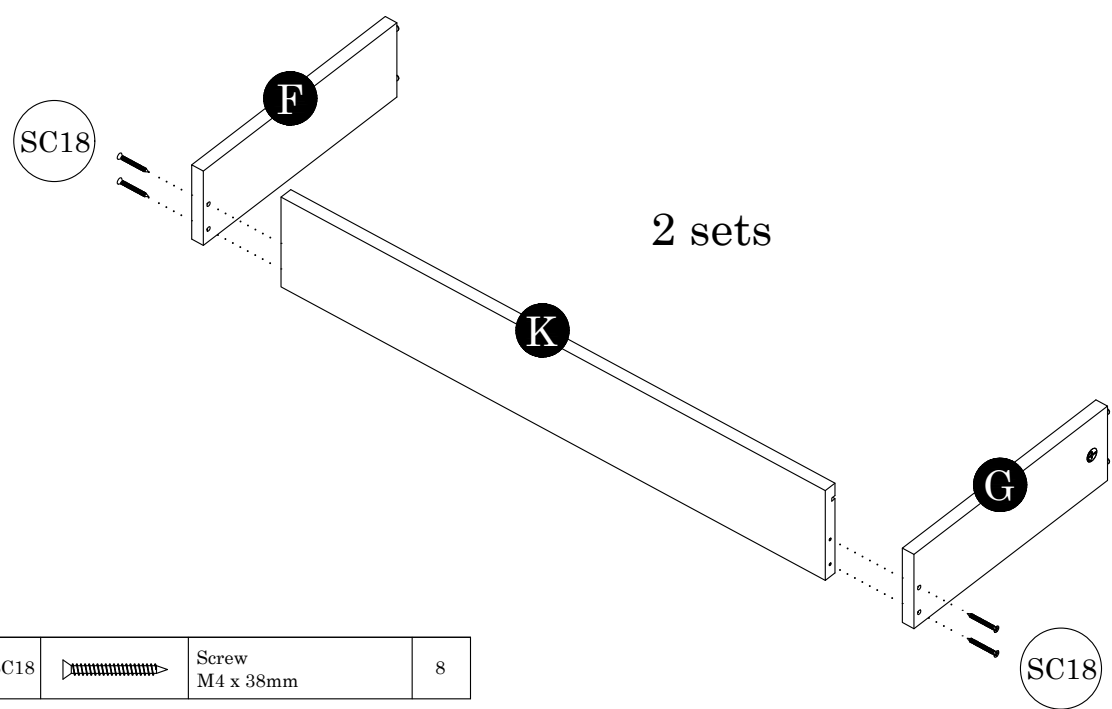

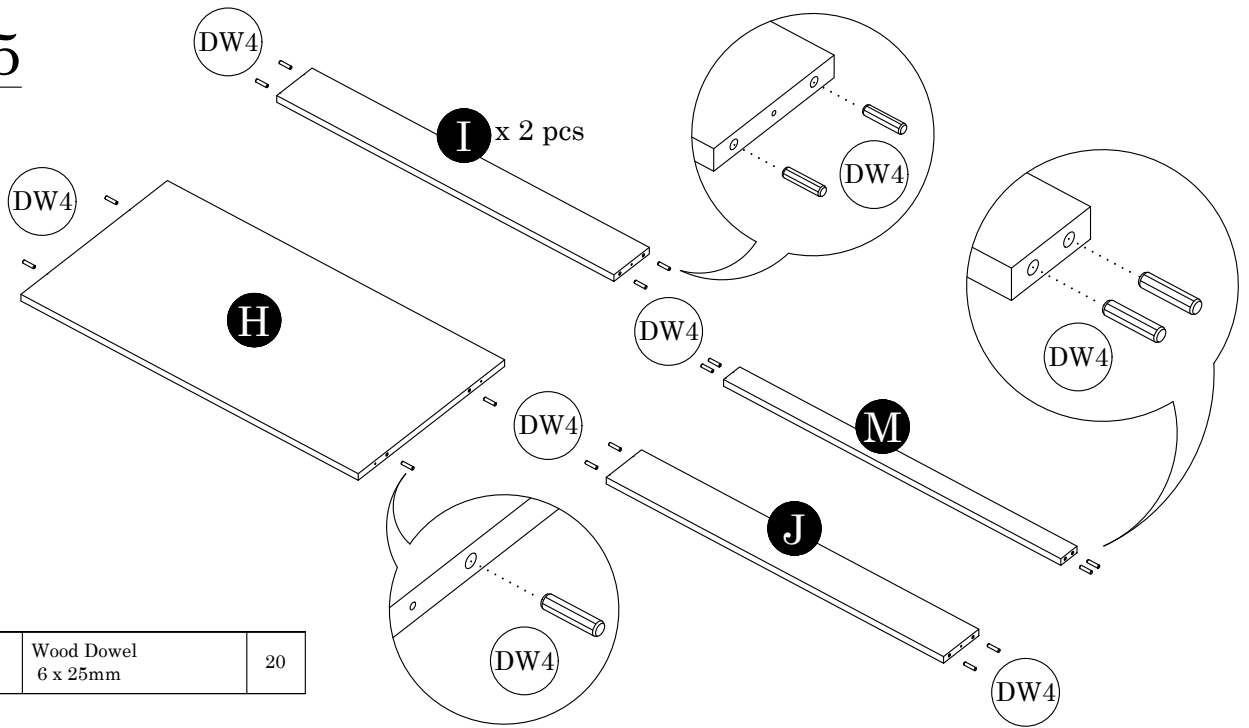

SC18		Screw M4 x 38mm	8
------	--	--------------------	---

STEP 5



DW4		Wood Dowel 6 x 25mm	20
-----	---	------------------------	----

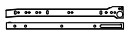

STEP 6

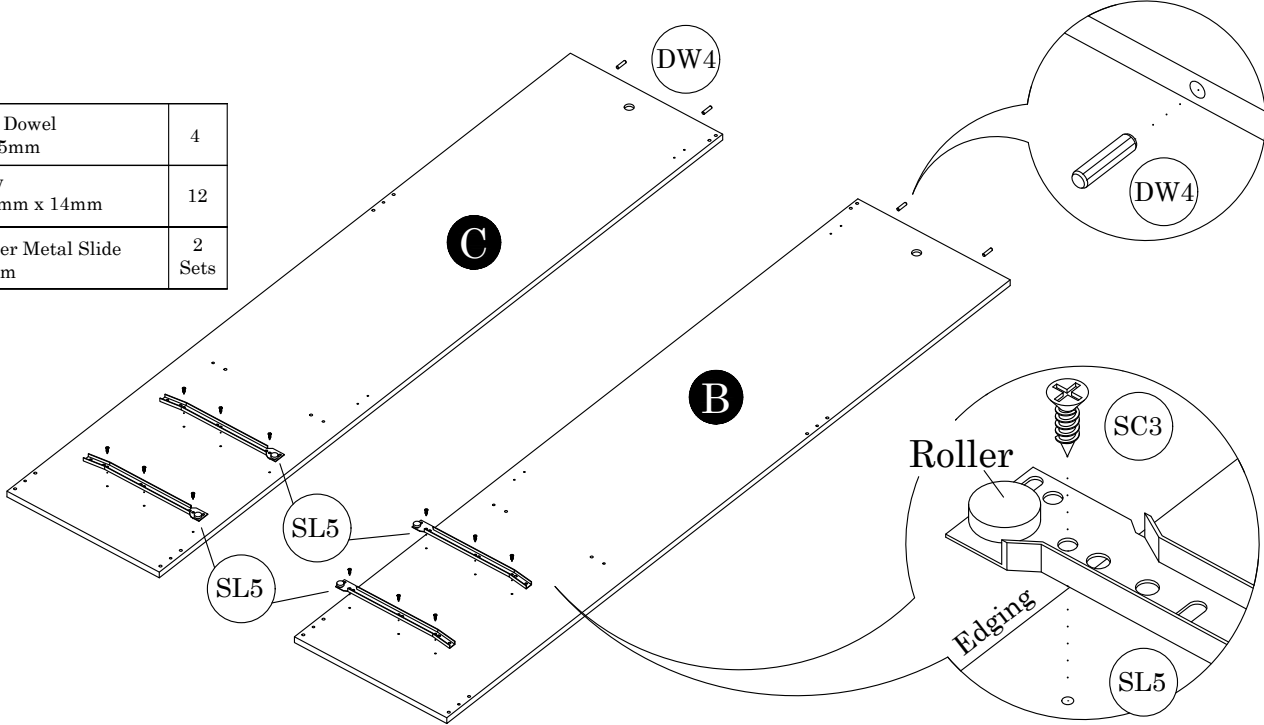
DW4		Wood Dowel 6 x 25mm	4
SC3		Screw M3.5mm x 14mm	12
SL5		Drawer Metal Slide 300mm	2 Sets

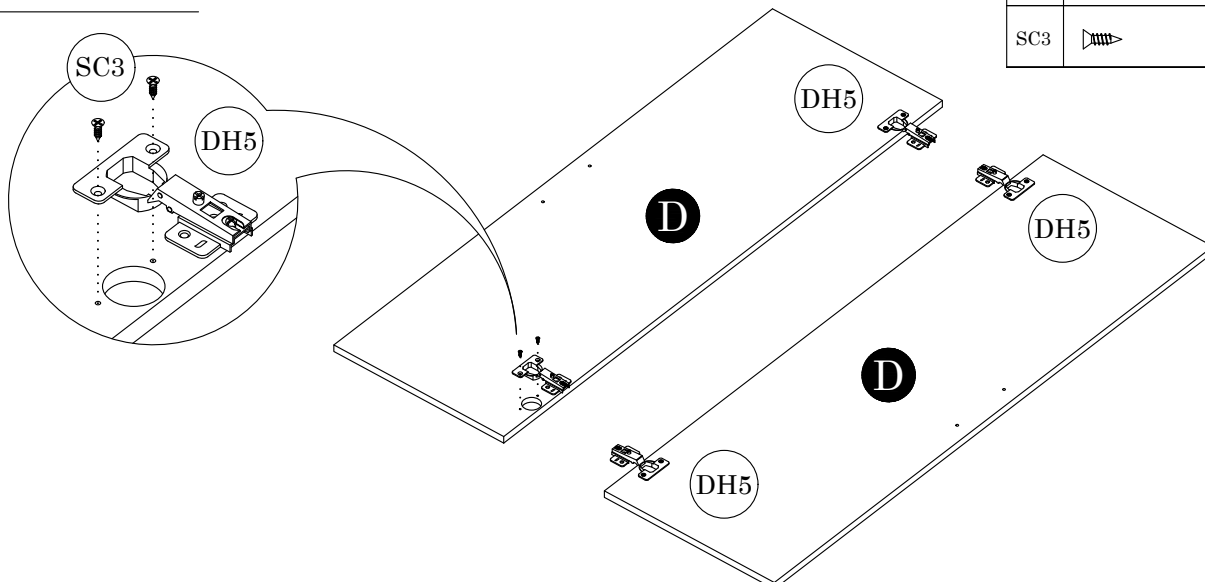

STEP 7



DH5		Soft Closing Hinges 5/8	4 Sets
SC3		Screw M3.5mm x 14mm	8

STEP 8

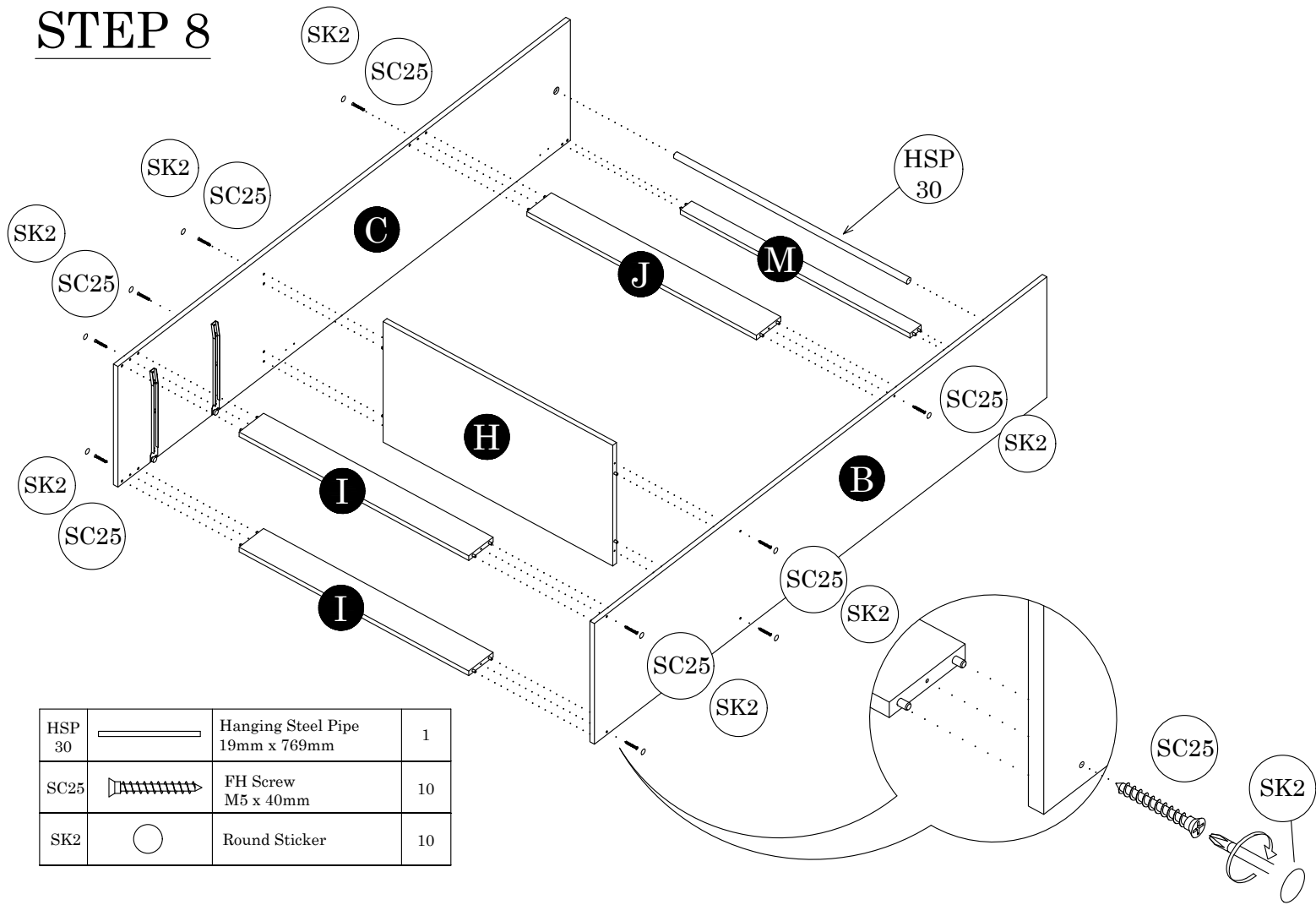

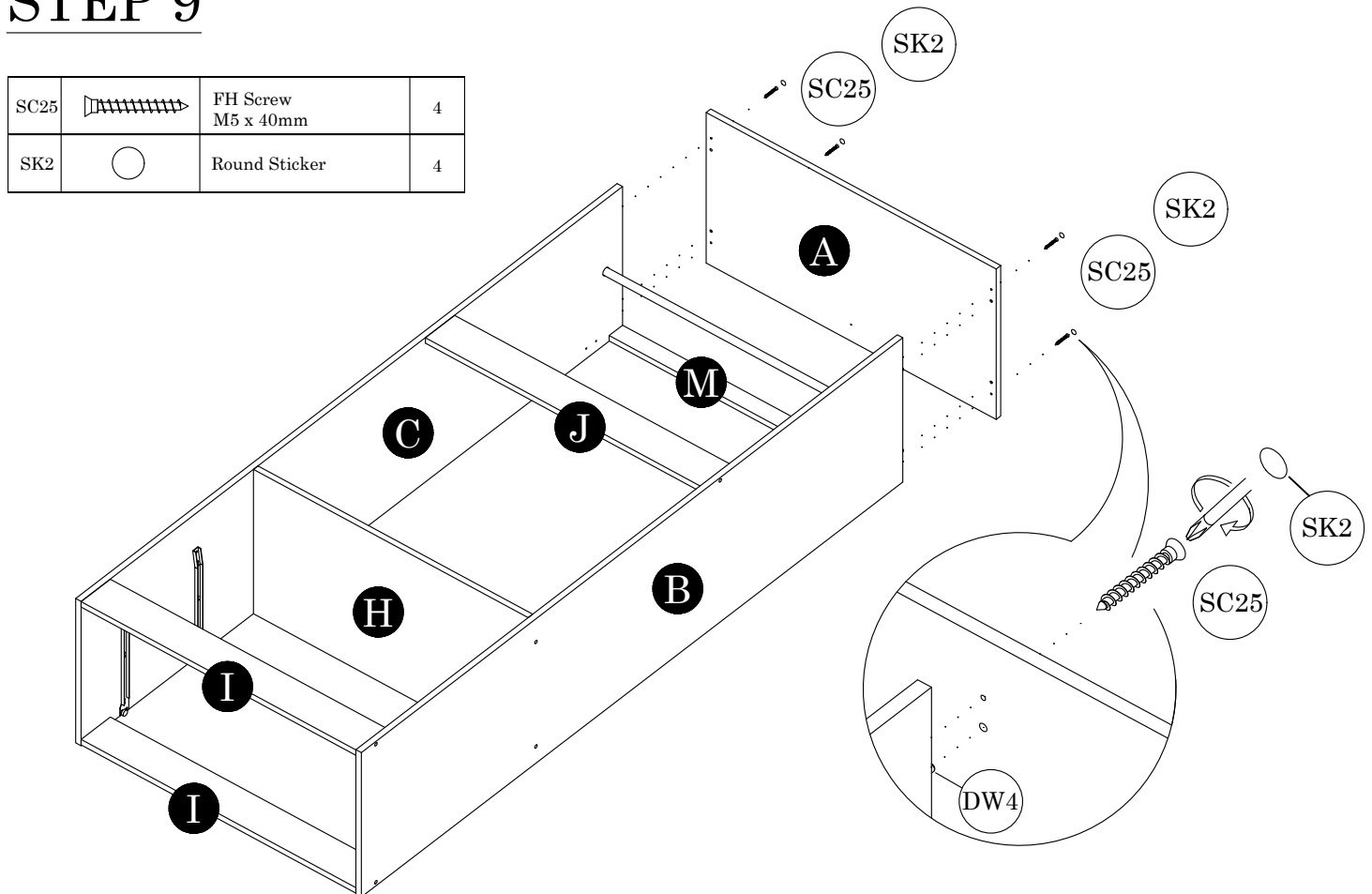

STEP 9



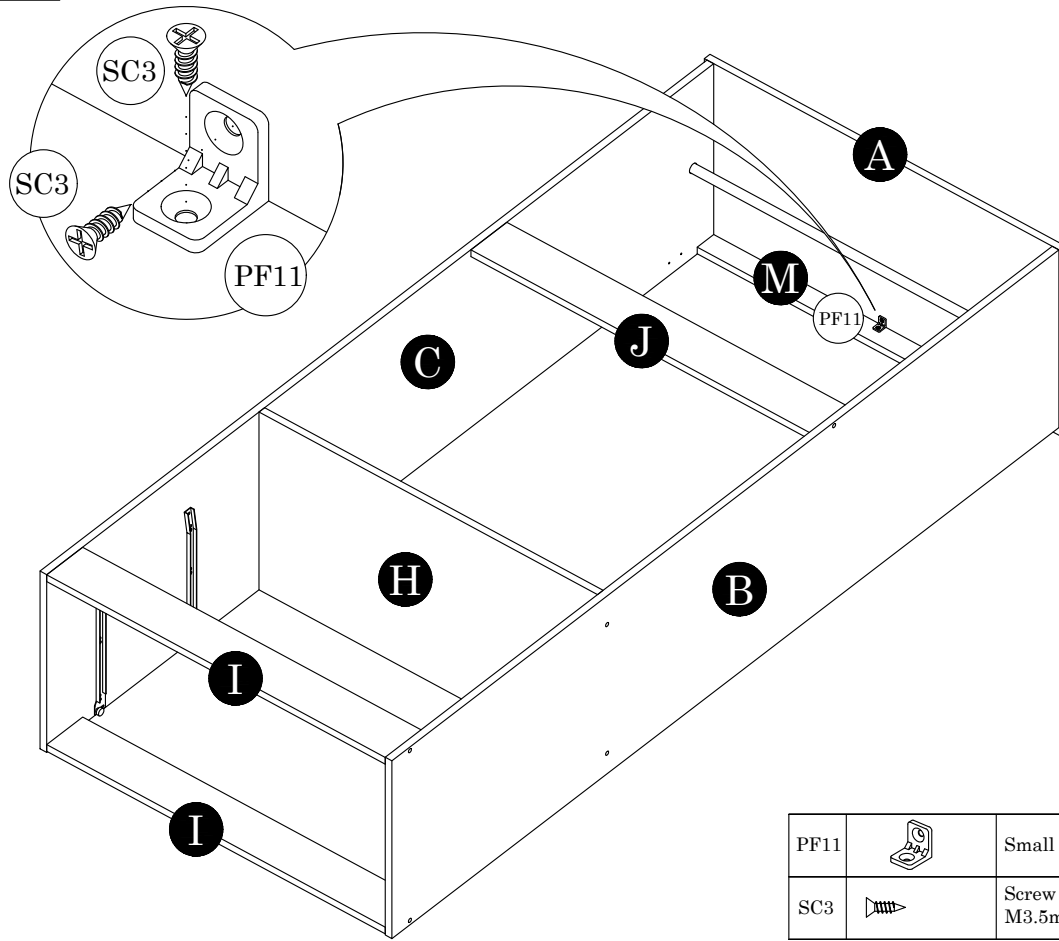



STEP 10

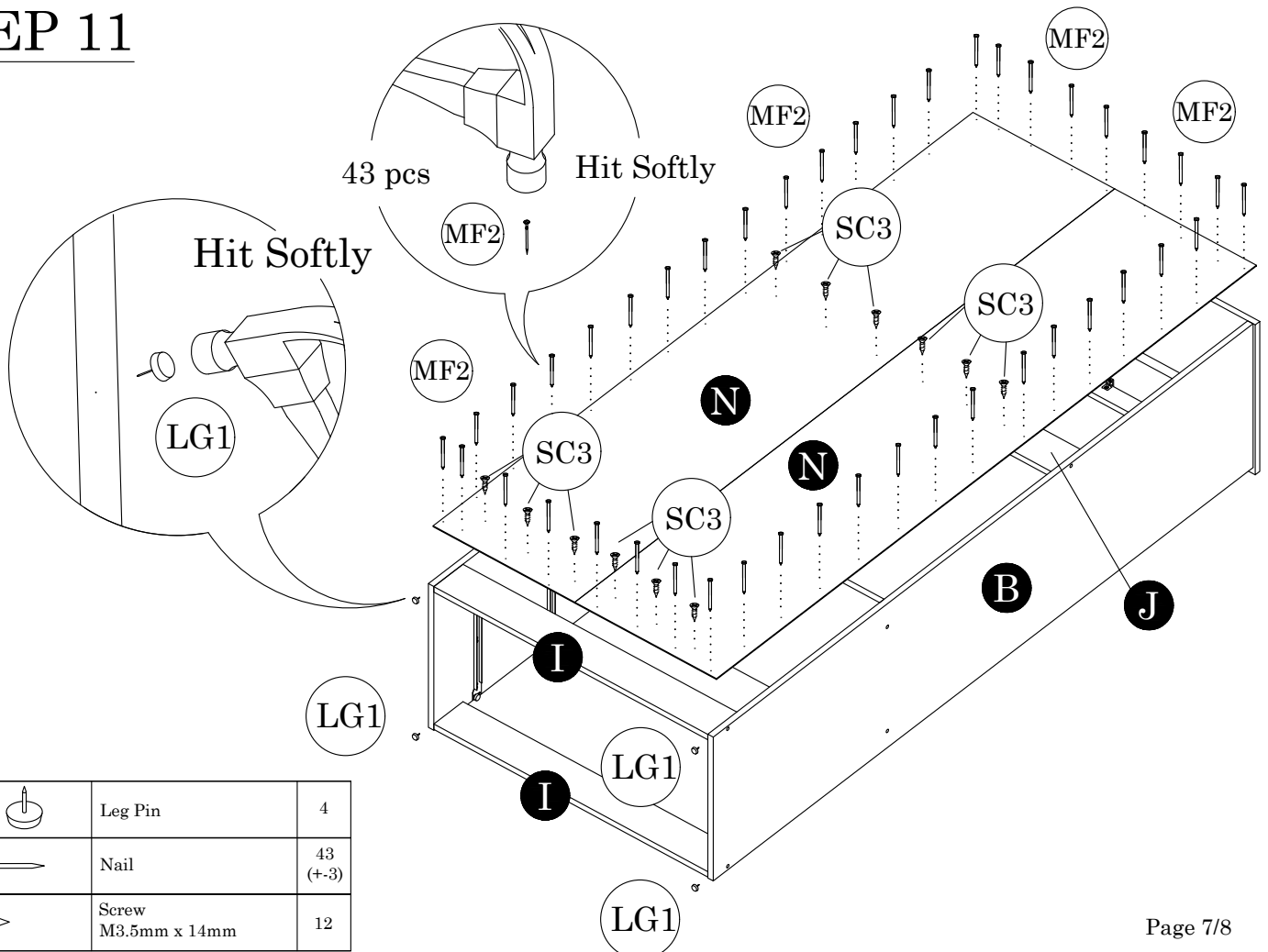

PF11		Small L Bracket	1
SC3		Screw M3.5mm x 14mm	2

STEP 11



LG1		Leg Pin	4
MF2		Nail	43 (+3)
SC3		Screw M3.5mm x 14mm	12

STEP 12

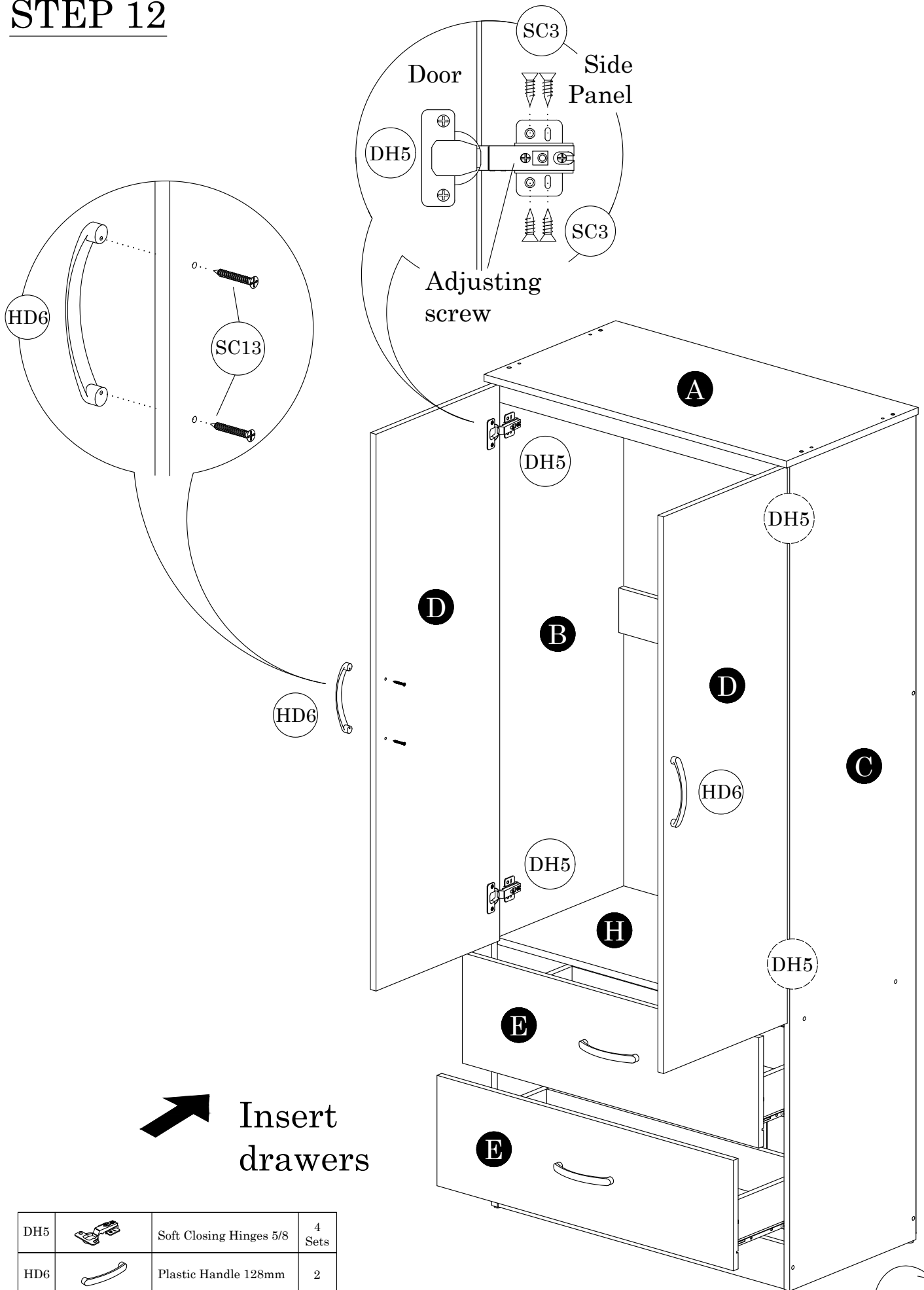

Insert drawers

DH5		Soft Closing Hinges 5/8	4 Sets
HD6		Plastic Handle 128mm	2
SC13		Screw M4mm x 30mm	4
SC3		Screw M3.5mm x 14mm	16

Stand up