

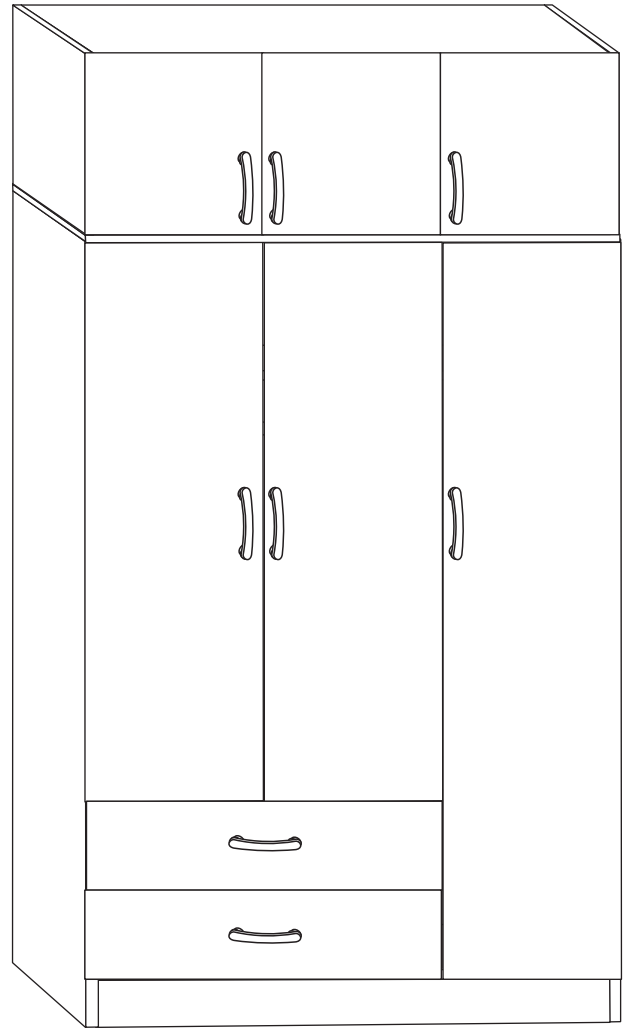

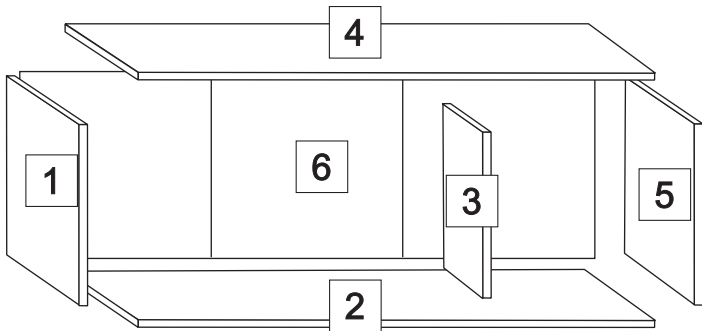





PRODUCT CODE : 249-00042

ASSEMBLY INSTRUCTIONS

Please Keep For Future Reference



HARDWARE

<p>(A)</p>  <p>JCBC M6 X 40mm X 8</p>	<p>(B)</p>  <p>M4 X 25mm X 12</p>	<p>(C)</p>  <p>M3.5 X 14mm X 24</p>	<p>(D)</p>  <p>Nail X 26</p>
<p>(E)</p>  <p>Handle X 3</p>	<p>(F)</p>  <p>Hinge X 6</p>	<p>(G)</p>  <p>Dowel 8 X 25mm X 4</p>	<p>(H)</p>  <p>Allen Key X 1</p>

Ruler- Use this ruler to help correctly identify the bolts.



STEP 1

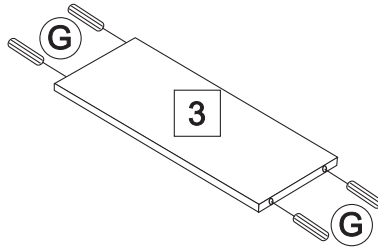

STEP 2

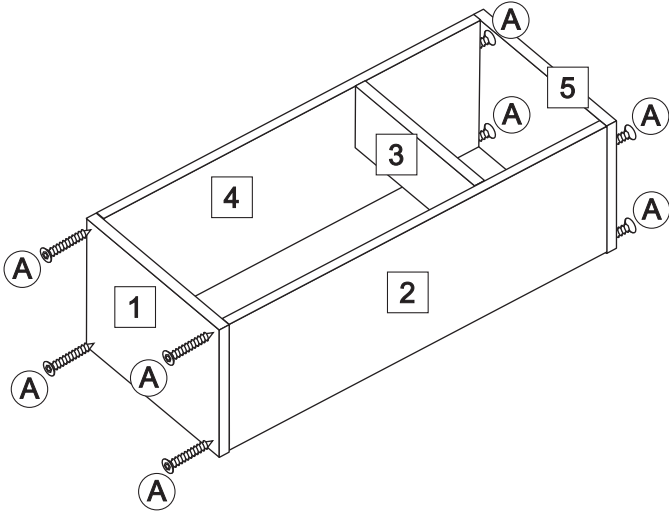

STEP 3

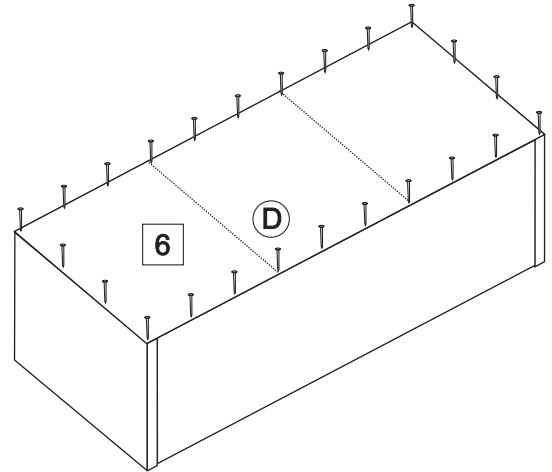

STEP 4

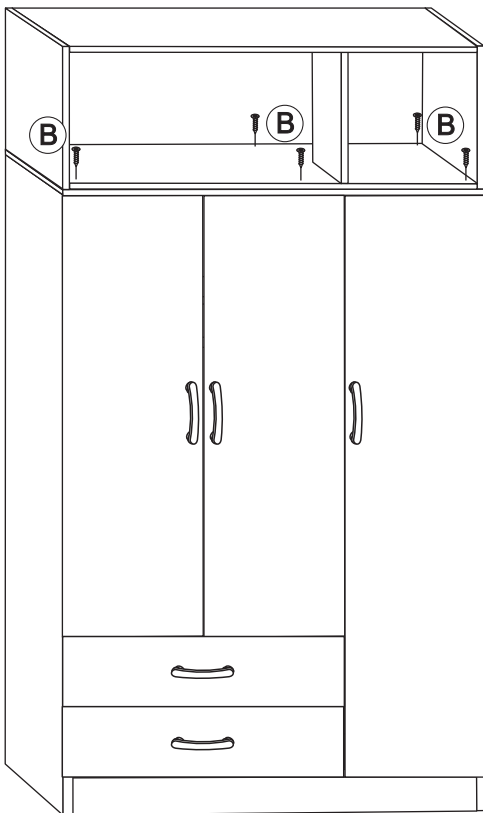

STEP 5

