

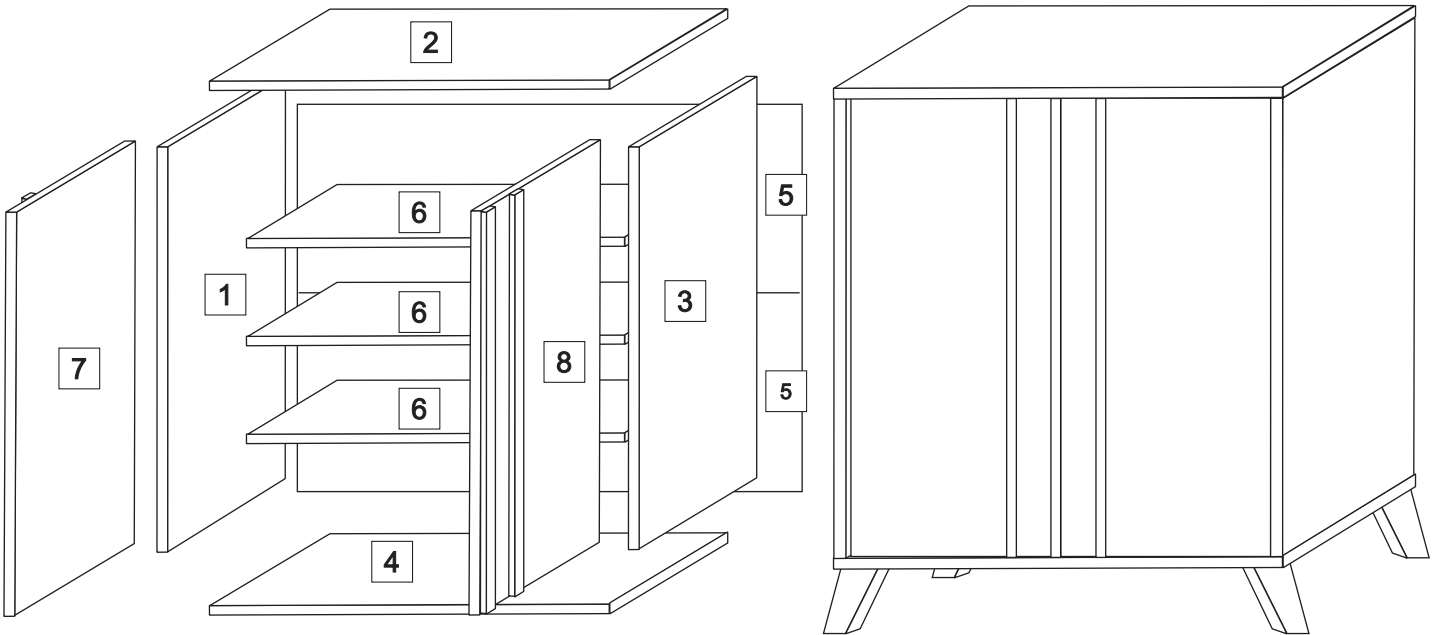







# PRODUCT CODE : 249-000035

## ASSEMBLY INSTRUCTIONS

Please Keep For Future Reference



### HARDWARE

A	B	C	D	E	F	G
 JCBC M5 X 40mm X 8	 M3.5 X 14mm X 40	 Nail X 25	 Metal Shelf Support X 16	 Hinges X 4	 Plastic Leg X 4	 Allen Key X 1

Ruler- Use this ruler to help correctly identify the bolts.



STEP 1

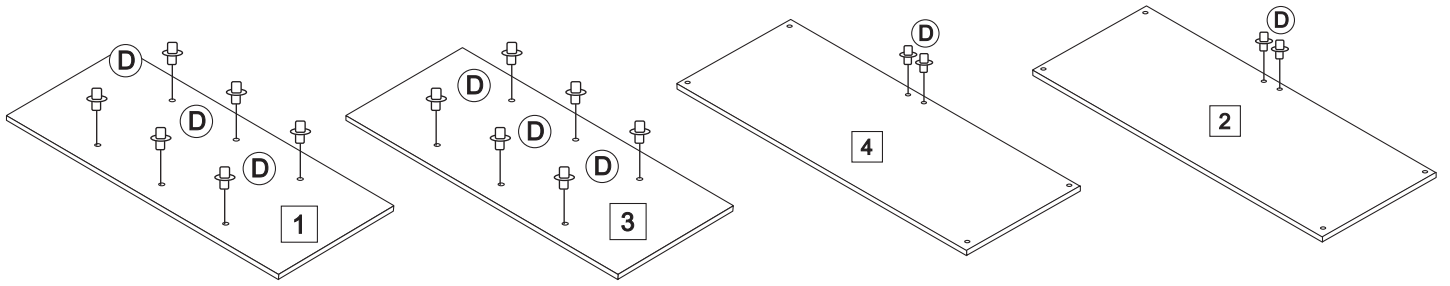

STEP 2

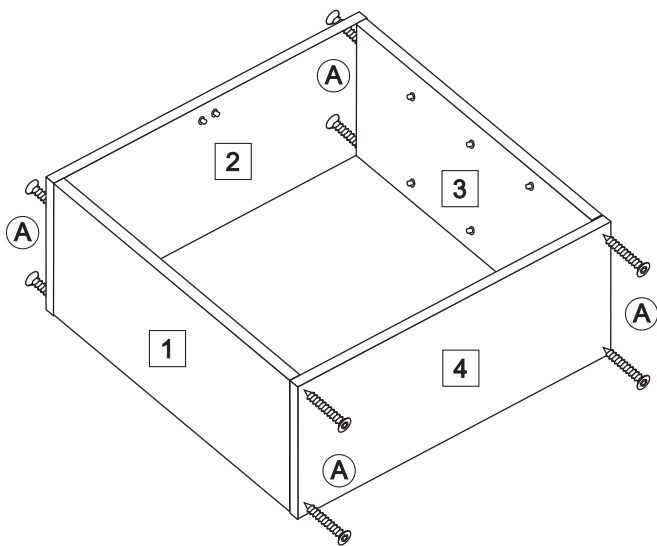

STEP 3

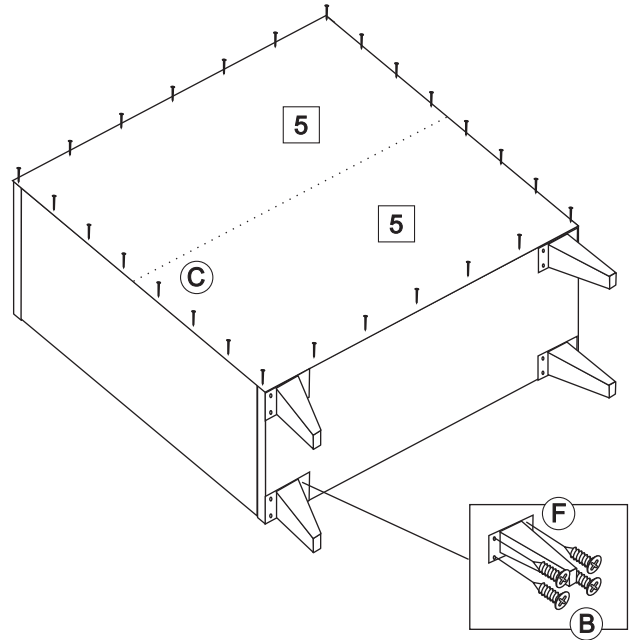

STEP 4

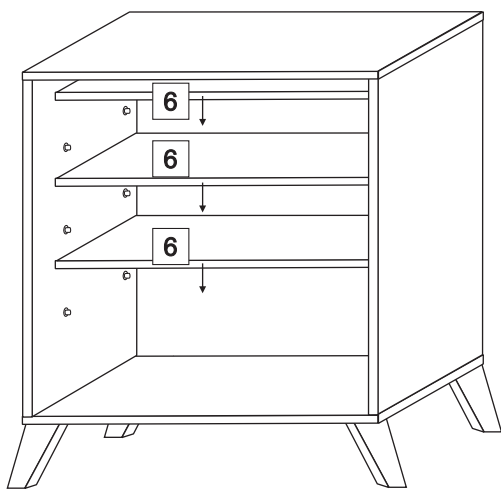

Complete

