

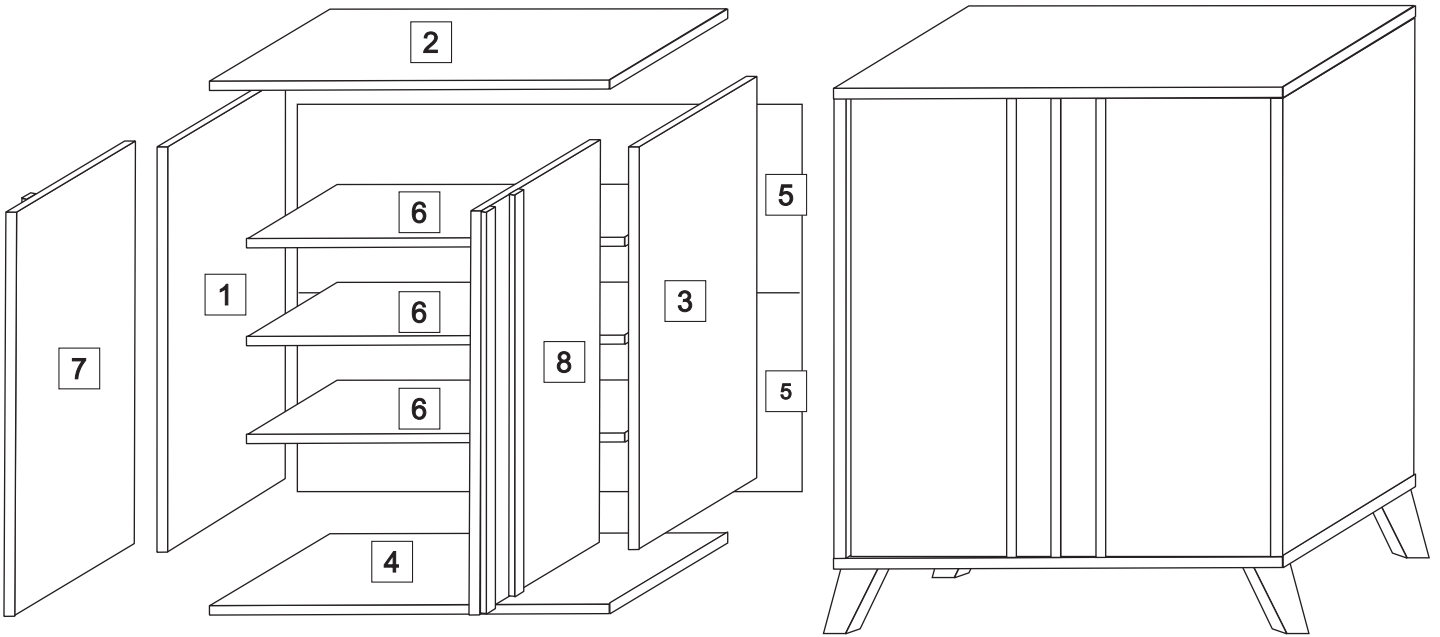







PRODUCT CODE : 249-000034

ASSEMBLY INSTRUCTIONS

Please Keep For Future Reference



HARDWARE

A	B	C	D	E	F	G
						
JCBC M5 X 40mm X 8	M3.5 X 14mm X 40	Nail X 25	Metal Shelf Support X 16	Hinges X 4	Plastic Leg X 4	Allen Key X 1

Ruler- Use this ruler to help correctly identify the bolts.



STEP 1

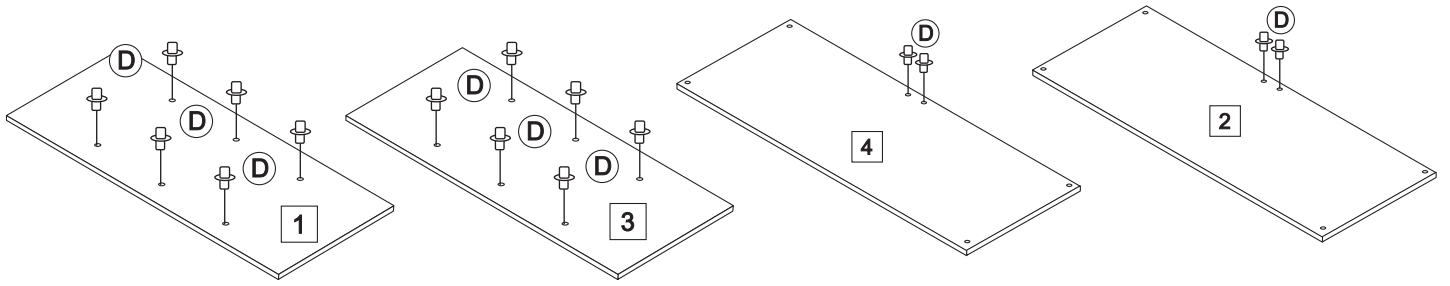

STEP 2

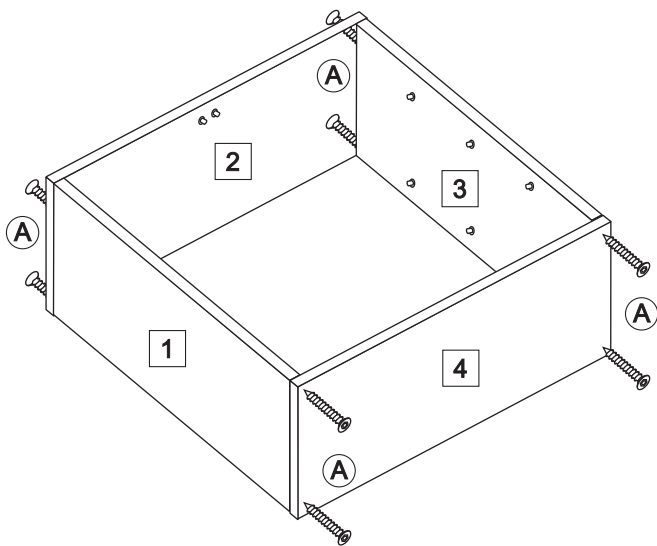

STEP 3

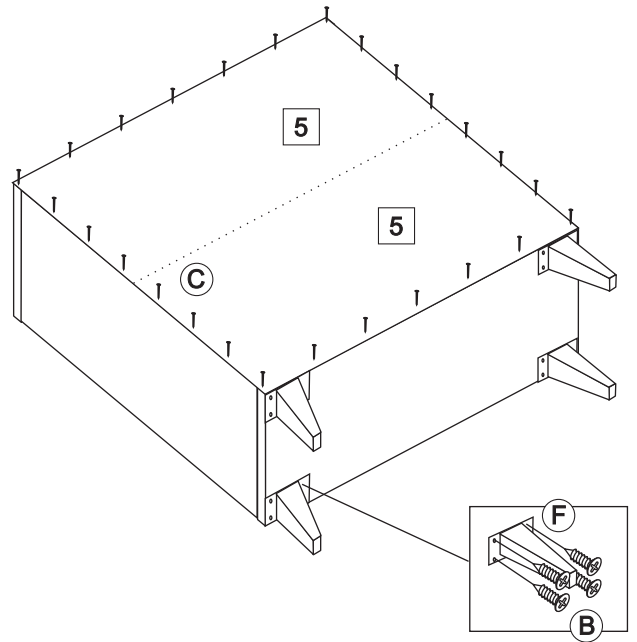

STEP 4

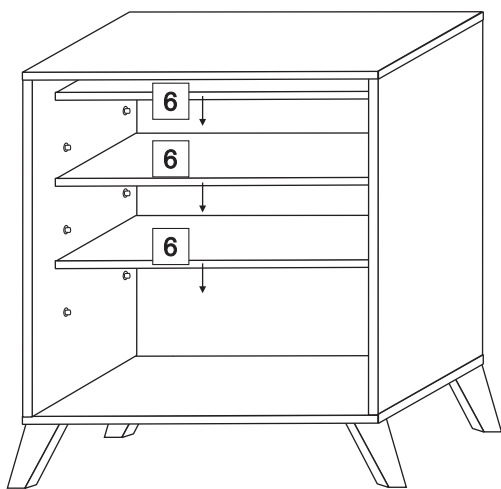

Complete

