

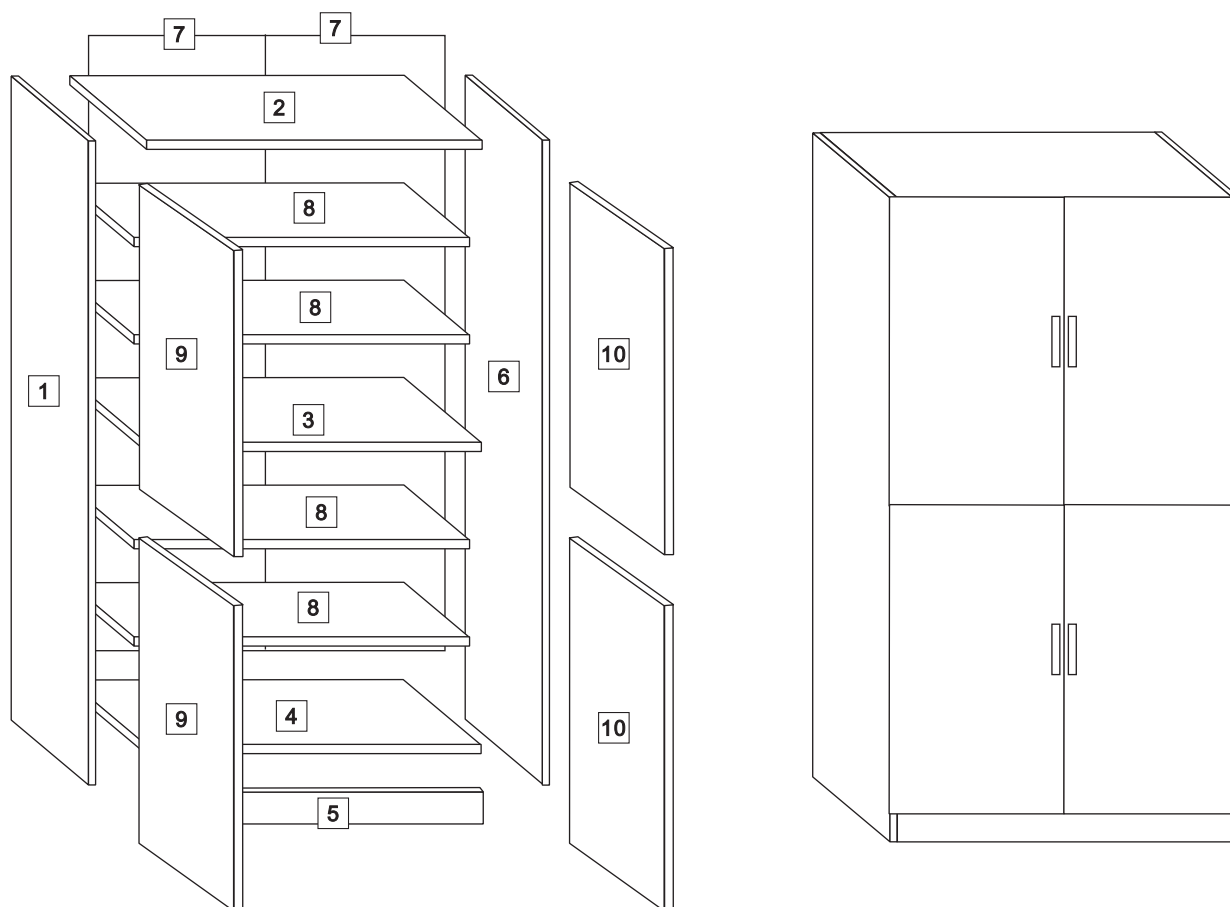









PRODUCT CODE: 249-000033

ASSEMBLY INSTRUCTIONS

Please Keep For Future Reference



HARDWARE				
<p>(A)</p>  <p>JCBC M6 X 40mm X 14</p>	<p>(B)</p>  <p>M4 X 30mm X 8</p>	<p>(C)</p>  <p>M3.5 X 14mm X 32</p>	<p>(D)</p>  <p>Nail X 34</p>	<p>(E)</p>  <p>Shelf Support X 16</p>
<p>(F)</p>  <p>Handle X 4</p>	<p>(G)</p>  <p>Hinge X 8</p>	<p>(H)</p>  <p>Leg Pin X 4</p>	<p>(I)</p>  <p>Allen Key X 1</p>	

Ruler- Use this ruler to help correctly identify the bolts.



STEP 1

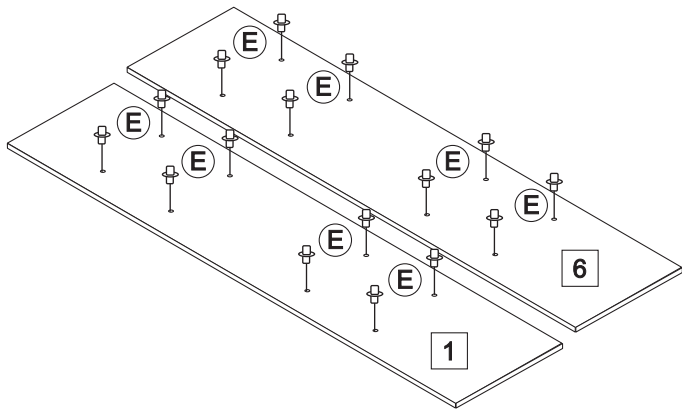

STEP 2

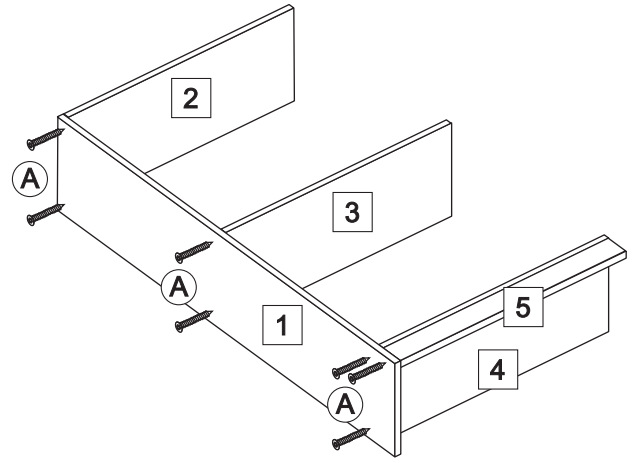

STEP 3

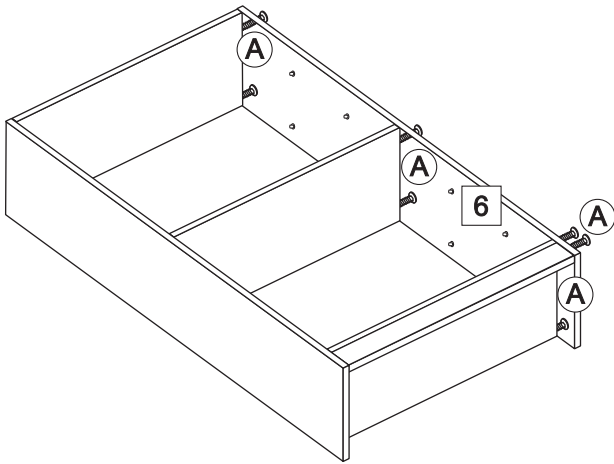

STEP 4

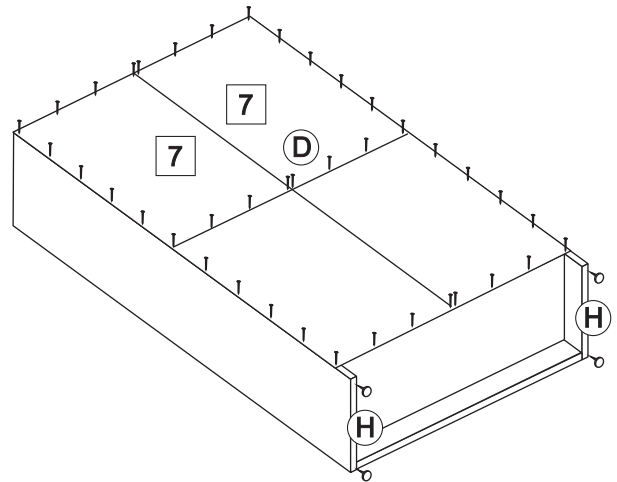

STEP 5

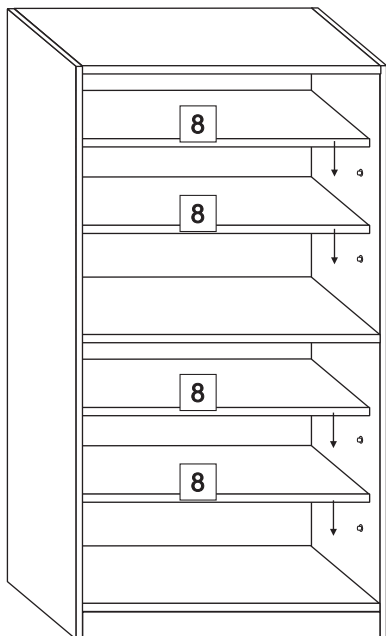

STEP 6

