

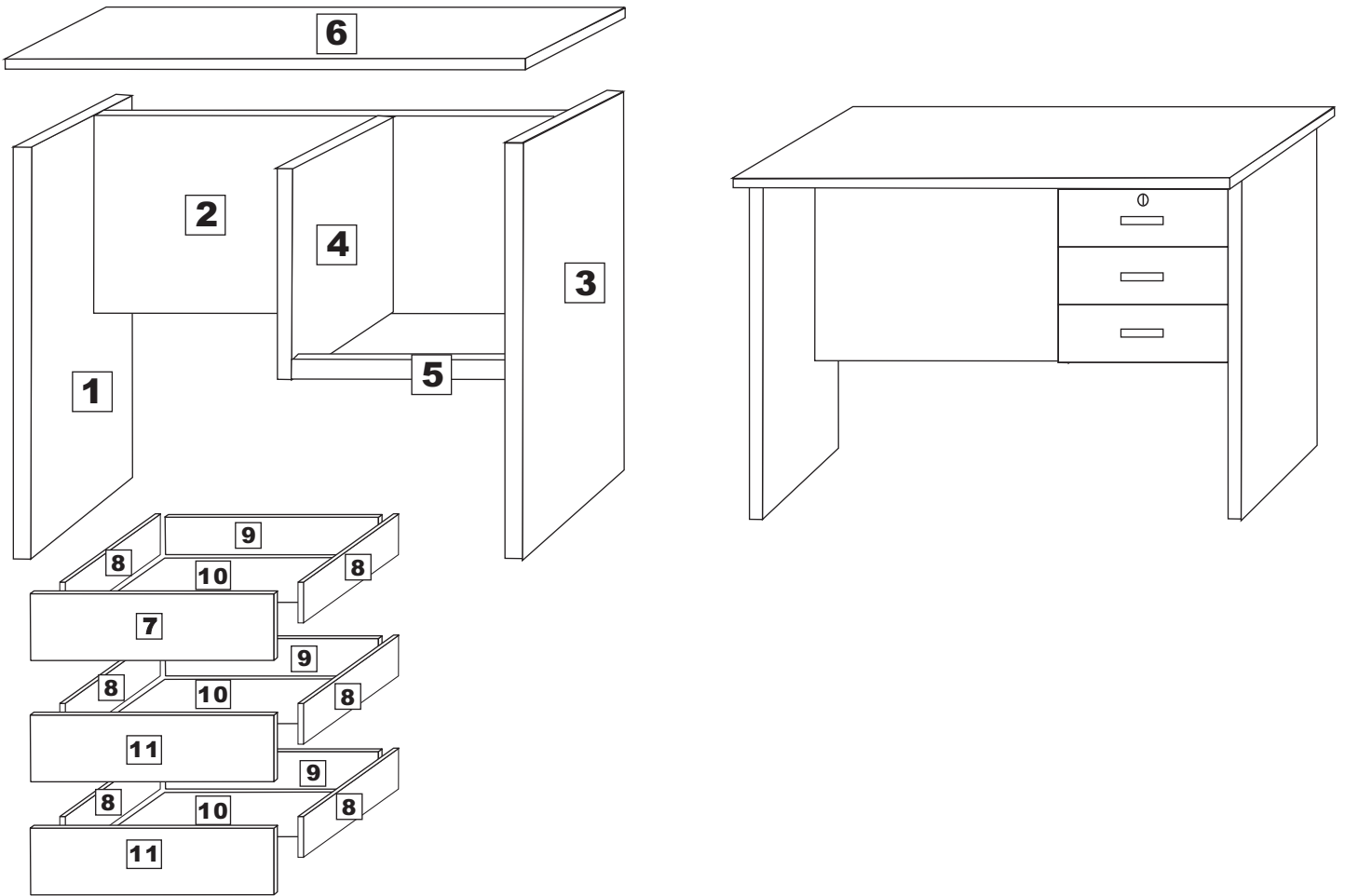













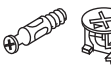

PRODUCT CODE : 249-000010

ASSEMBLY INSTRUCTIONS

Please Keep For Future Reference



HARDWARE							
(A)  JCBC M6 X 40mm X 8	(B)  M4 X 32mm X 18	(C)  Allen Key X 1	(D)  M3.5 X 20mm X 4	(E)  M3.5 X 14mm X 42	(F)  Nail X 18	(G)  Dowel (M8X25) X 5	(H)  Dowel (M6X25) X 6
(I)  Drawer Slide X 3 sets	(J)  Mini Fit X 6 sets	(K)  L-Bracket X 5	(L)  Handle X 3	(M)  Leg Pin X 4	(N)  Cam Lock X 1	(O)  Lock Stopper X 1	

Ruler- Use this ruler to help correctly identify the bolts.



STEP 1

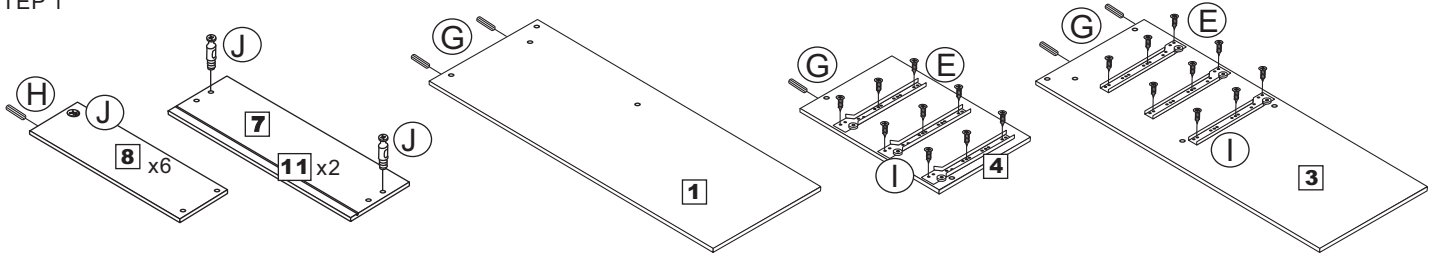

STEP 2

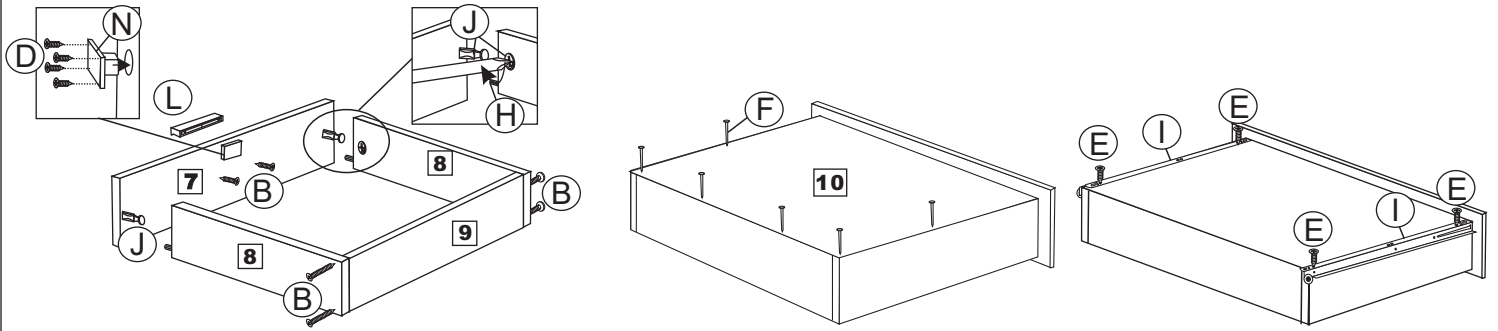

STEP 3

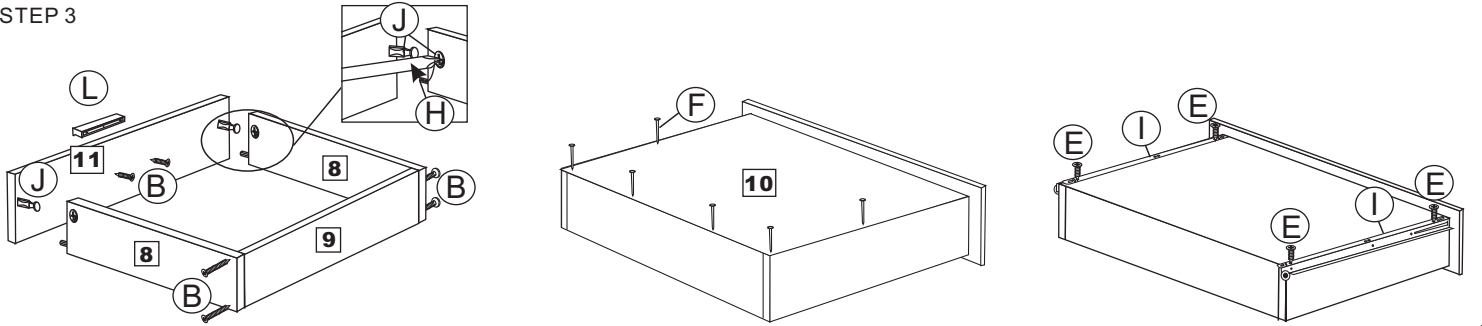

x2

STEP 4

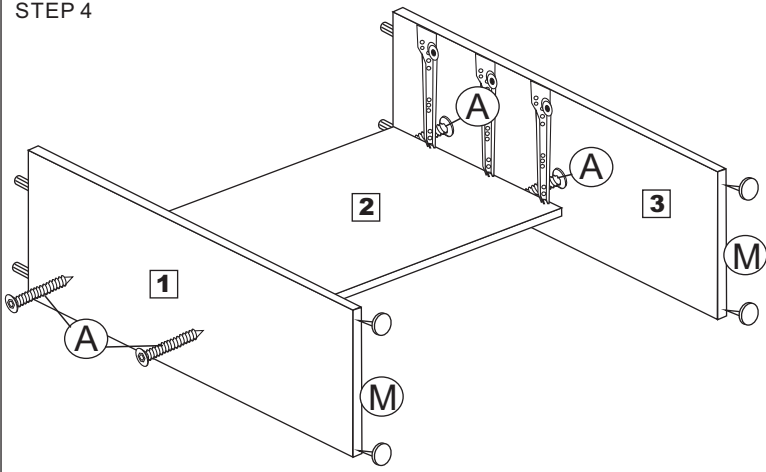

STEP 5

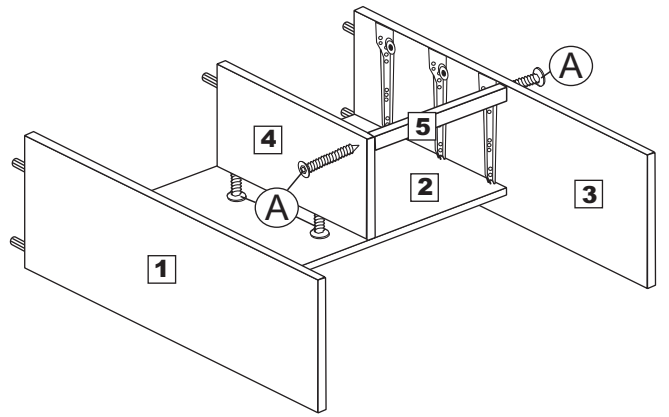

STEP 6

