

230-000022

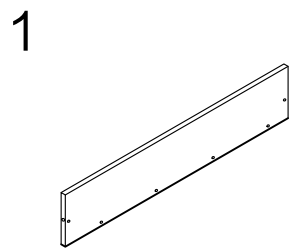

X2

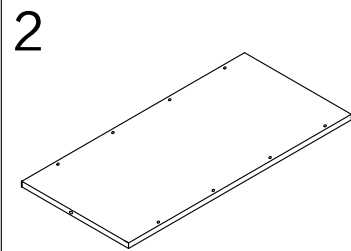

X1

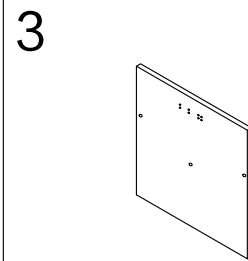

X2

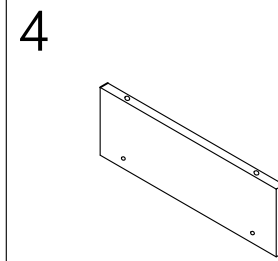

X1

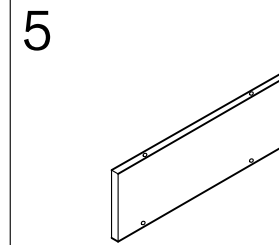

X1

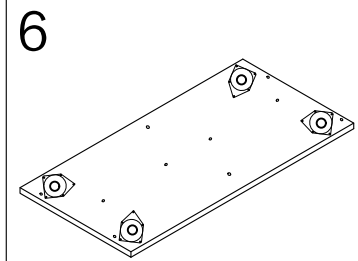

X2

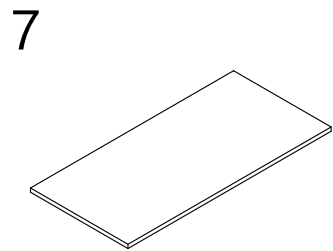

X1

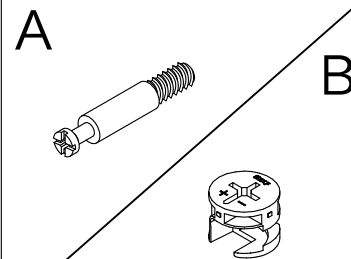

B



X20

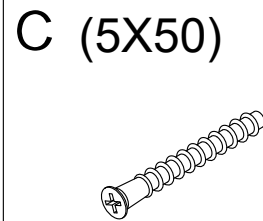

X10

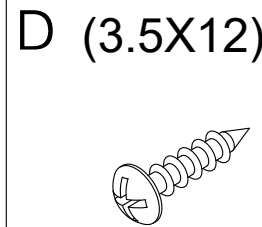

X20

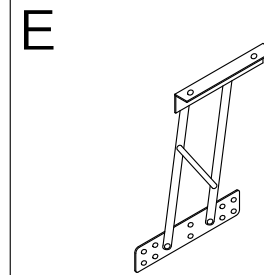

X2

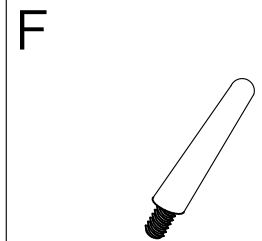

X4

Step 1

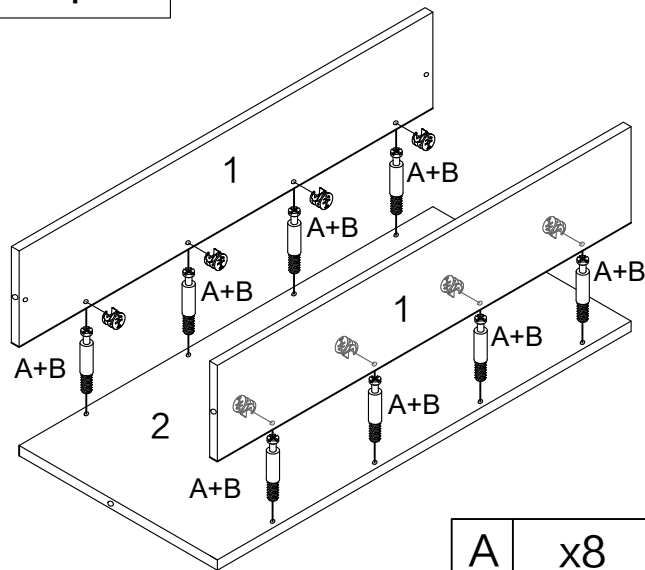

A	x8
B	x8

Step 2

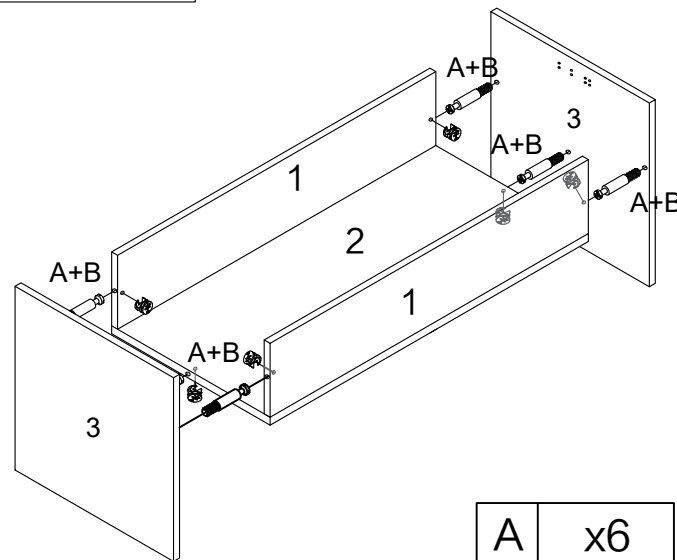

A	x6
B	x6

Step 3

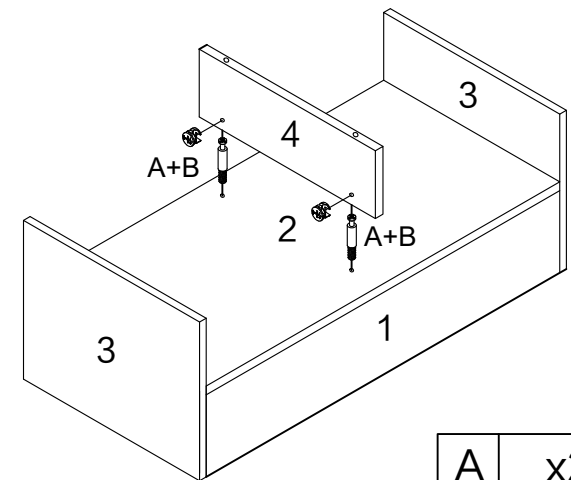

A	x2
B	x2

Step 4

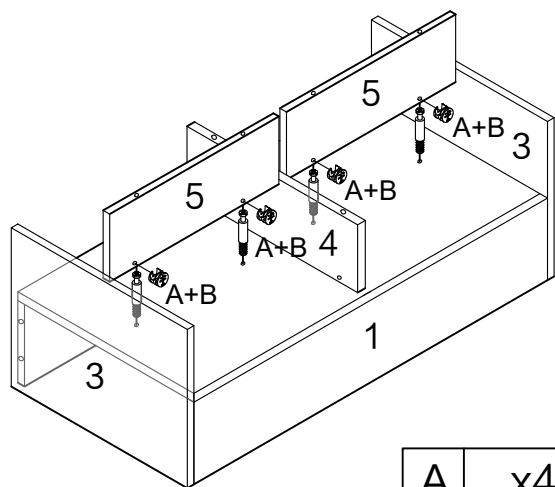

A	x4
---	----

B	x4
---	----

Step 5

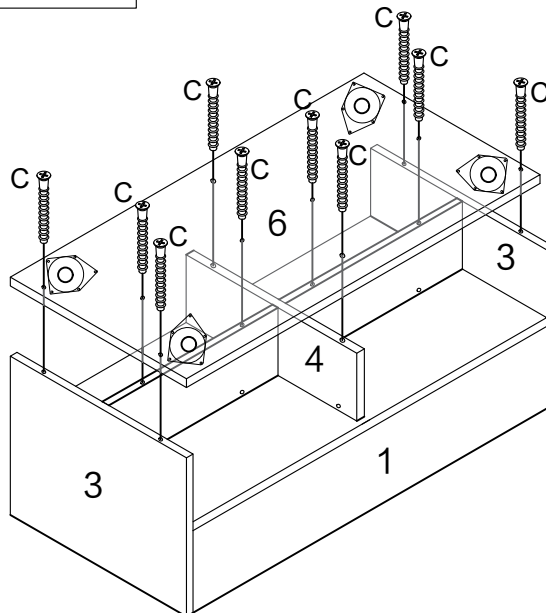

C	x10
---	-----

Step 6

Screw the F leg into the patch hole on board 6

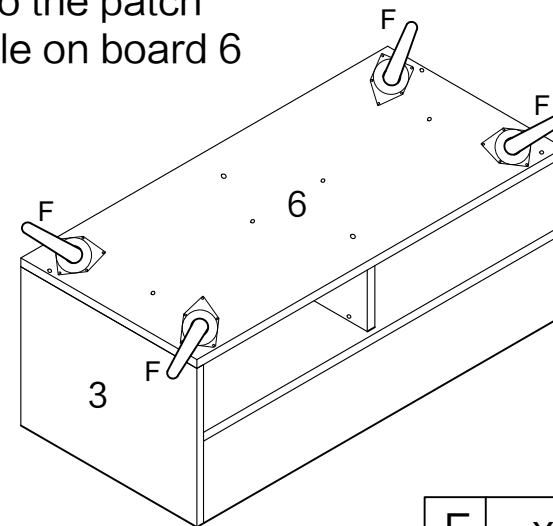

F	x4
---	----

Step 7

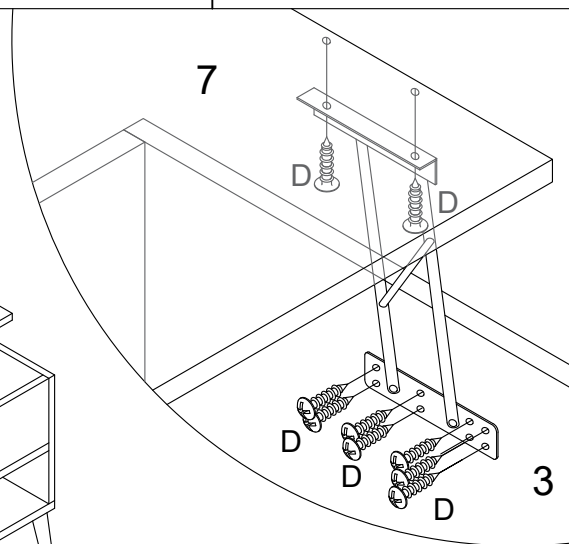
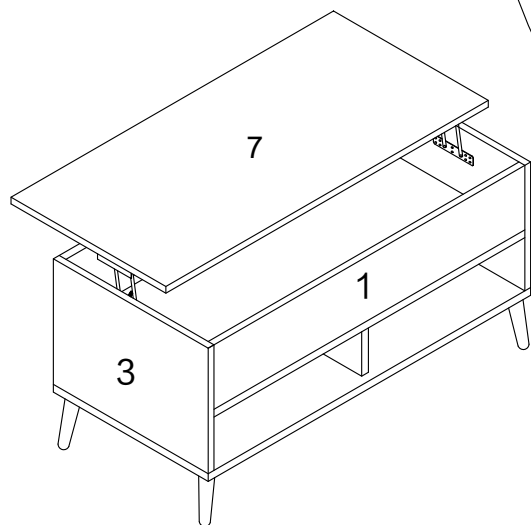

D	x20
---	-----

complete

