

230-000005

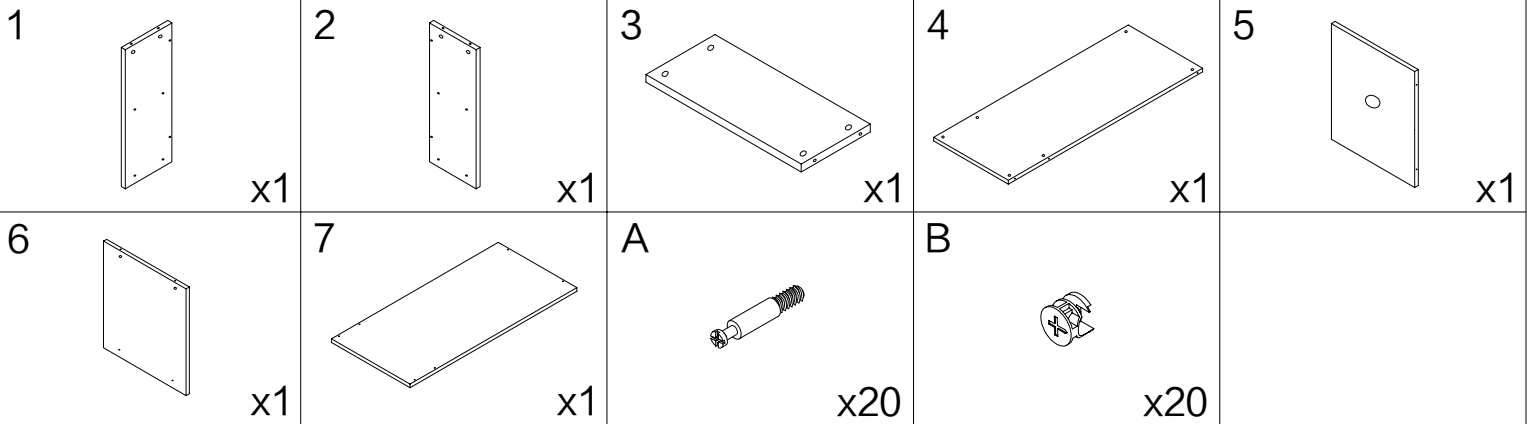

Step 1

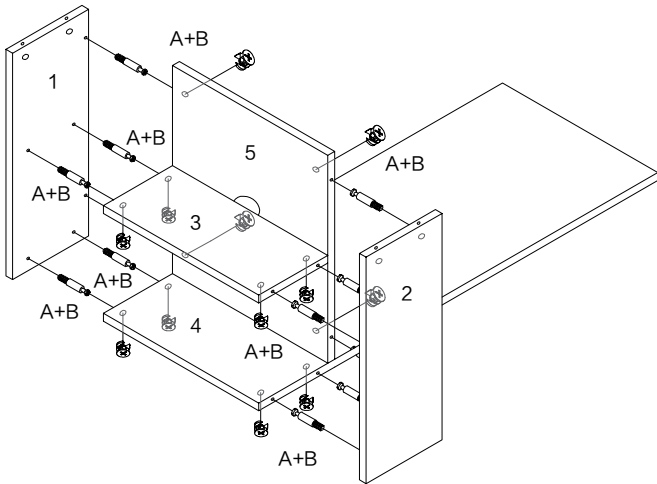

A x12

B x12

Step 2

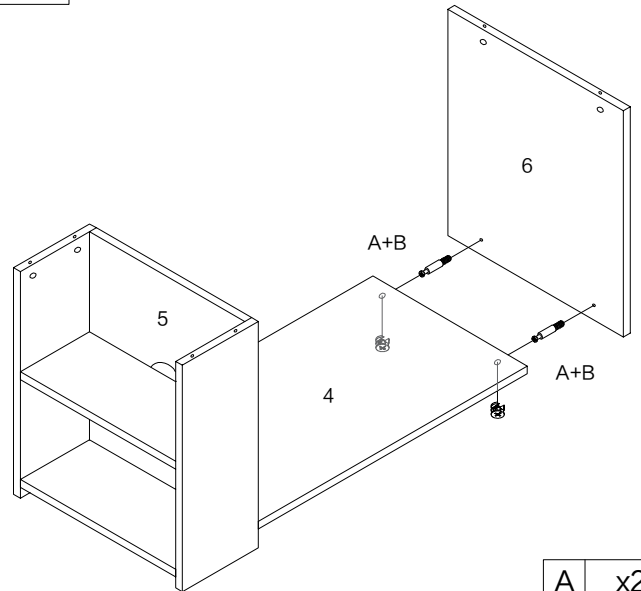

A x2

B x2

Step 3

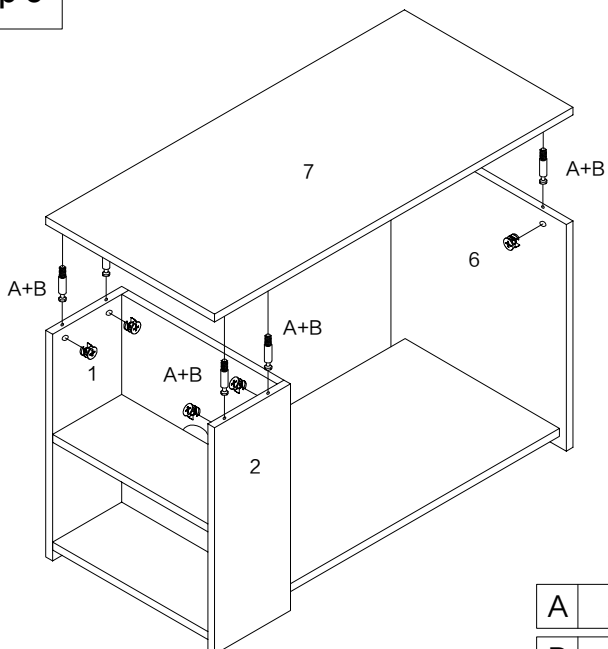

A x6

B x6

Complete

