

# Bedbase Assembly Instruction

197-000100

## Devices:

### For Single Bedbase



### For Double Bedbase

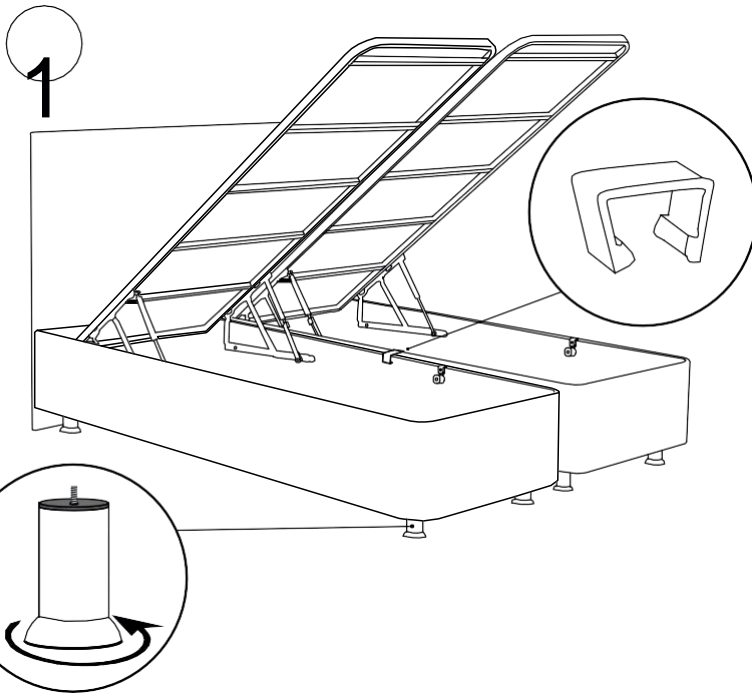

### ATTENTION!

You should pay attention to the bedbase cover.

Make sure that there are no children around during the installation.

When you turn the bedbase on its side, the lid may suddenly open and slam. That's why you have to open the lid first and then turn the base on its side.

When installing the bedbase legs, you need to pierce the fabric under the bedbase at the level of the holes on the metal profile.

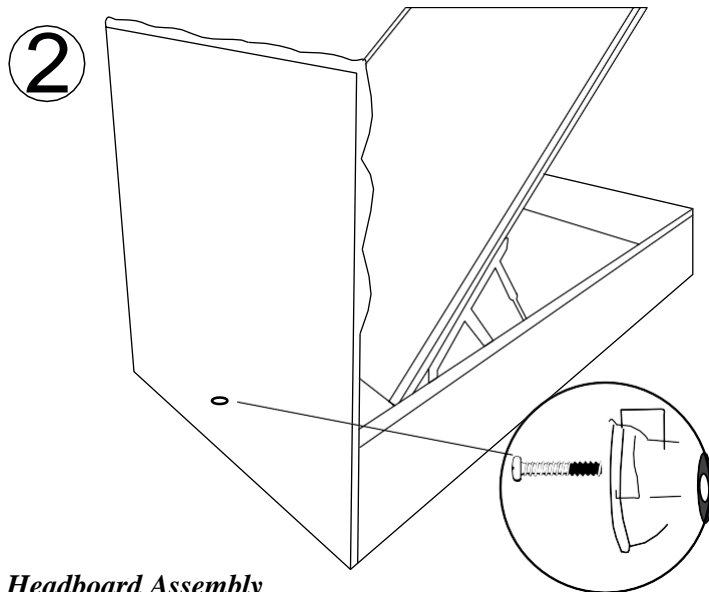

### Headboard Assembly

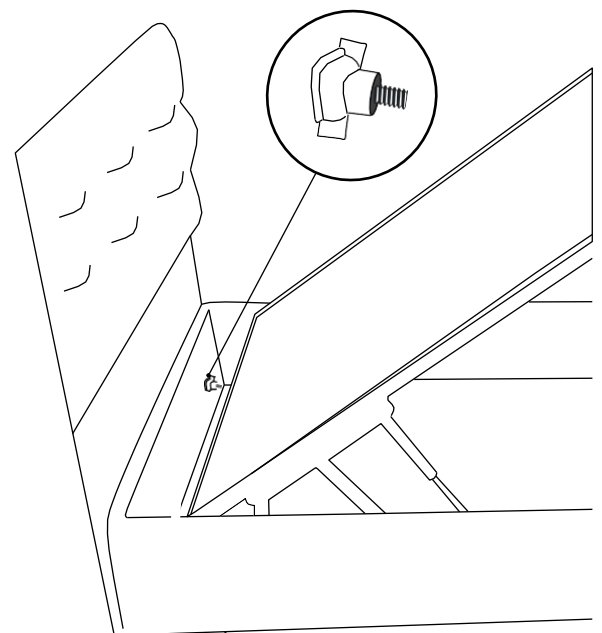

Mark the connection points of your bedbase or cot on the header with the help of a pencil. drill the head through the marked points and fix it in place with mounting screws.