

A	B	C	D	A	B	C	D		
1	KR1-030	2029	683	4/5	14	KR1-108	407	460	3/5
2	KR1-031	2029	683	4/5	15	KR1-333	689	455	3/5
3	KR1-028	2029	683	5/5	16	KR1-335	556	460	3/5
4	KR1-032	550	175	3/5	17	KR1-503	400	120	3/5
5	KR1-110	2155	608	1/5	18	KR1-504	400	120	3/5
6	KR1-111	2155	608	1/5	19	KR1-518	499	120	3/5
7	KR1-107	1619	460	1/5	20	KR1-913	399	514	3/5
8	KR1-109	1619	460	1/5	21	KR1-911	1634	704	5/5
9	KR1-331	1968	566	2/5	22	KR1-912	1634	572	5/5
10	KR1-330	1968	583	2/5	23	KR1-919	422	990	5/5
11	KR1-332	1968	460	2/5	24	DR-551	551		1/5
12	KR1-413	1968	80	2/5	25	DR-685	685		1/5
13	KR1-414	1968	80	2/5	26		1967		2/5

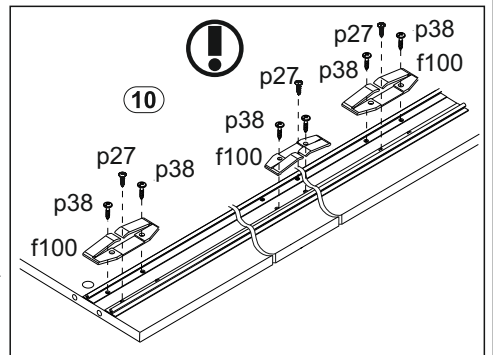

47x φ8x30 mm f1	44x r16	44x φ15x12mm #16 r1	12x φ5x17 mm d1	8x k1	4x φ3,5x13 mm p1	3x Stoper f100	4x φ3,5x16 mm p25
5x l1	4x n1	1x n26\1	36x ø16 s2	7x φ3,5x16 mm p38	24x l2	12x φ6x13 mm e3	49x φ3,5x13 mm p27
6x n181	6x n182	12x φ4x13 mm p28	12x φ5x12 mm e41	6x φ3,5x25 mm p42	8x φ5x50 mm e32	8x φ3x12 mm p54	2x 276 mm c806\1
2x 400 mm w5^{CL}	2x 400 mm w5^{CR}	2x 400 mm w5^{DL}	2x 400 mm w5^{DR}	2x 383 mm t14	3x silikon φ8x1,8mm o21	22x 20x13x3,5\1 n108	22x φ2,9x16 mm p55

1

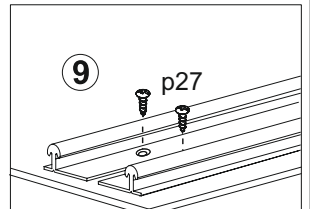
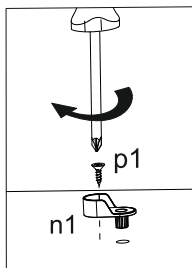
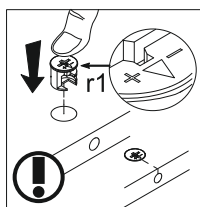
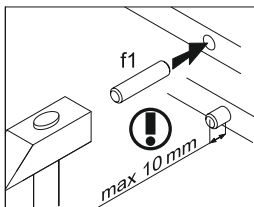
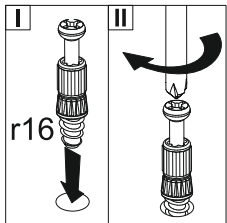
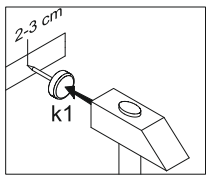
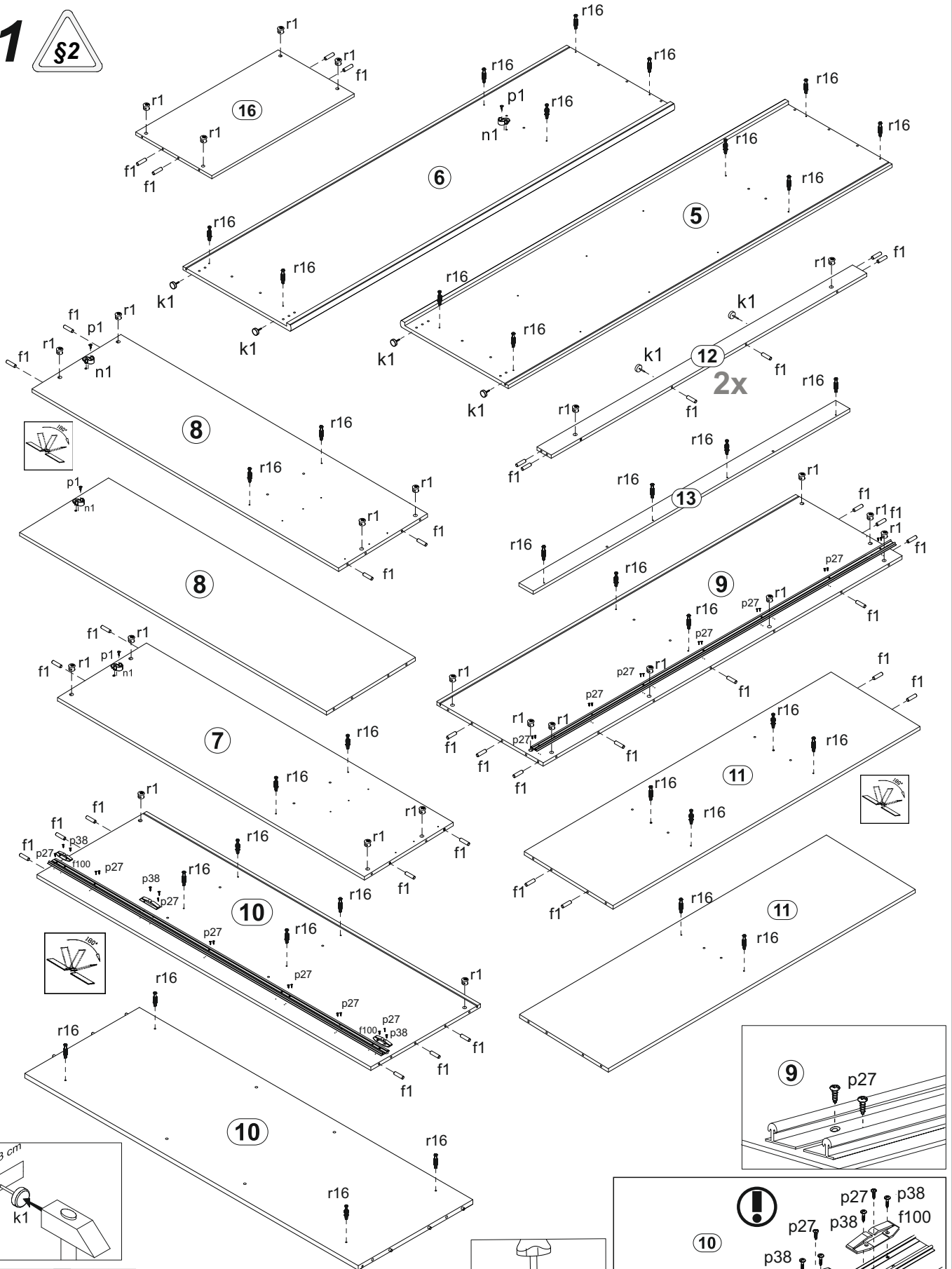

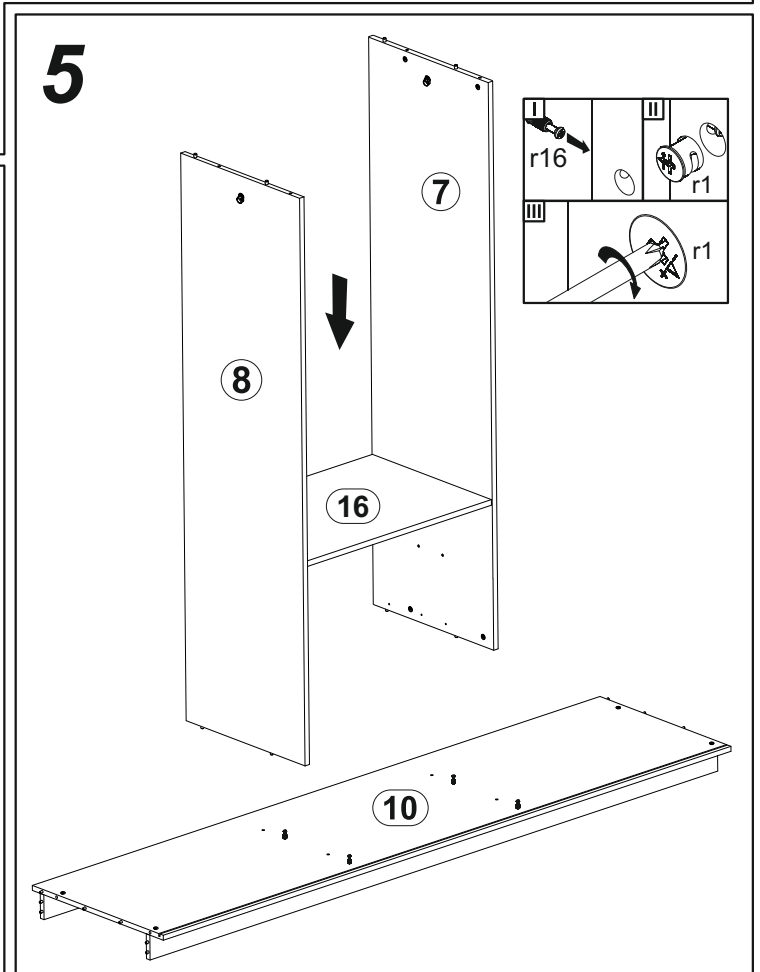
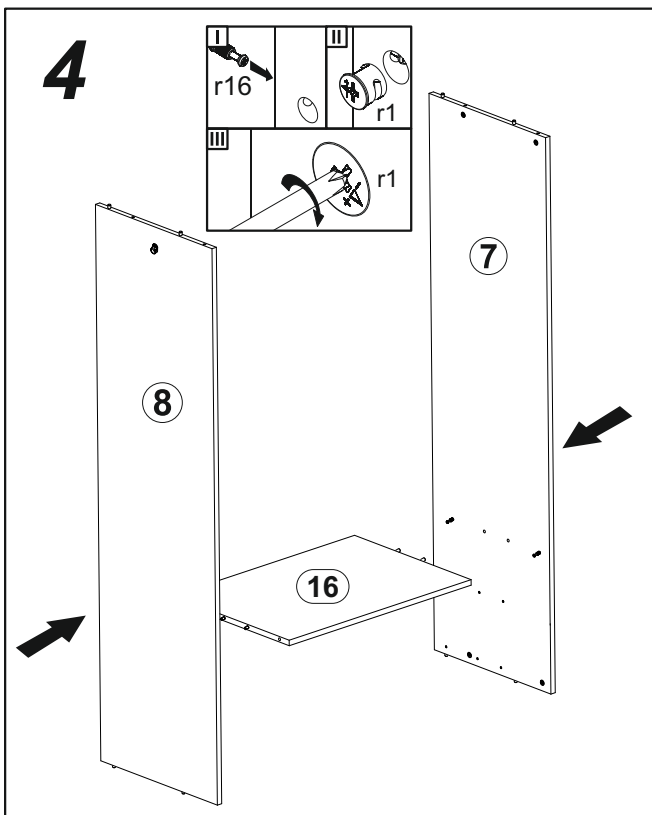
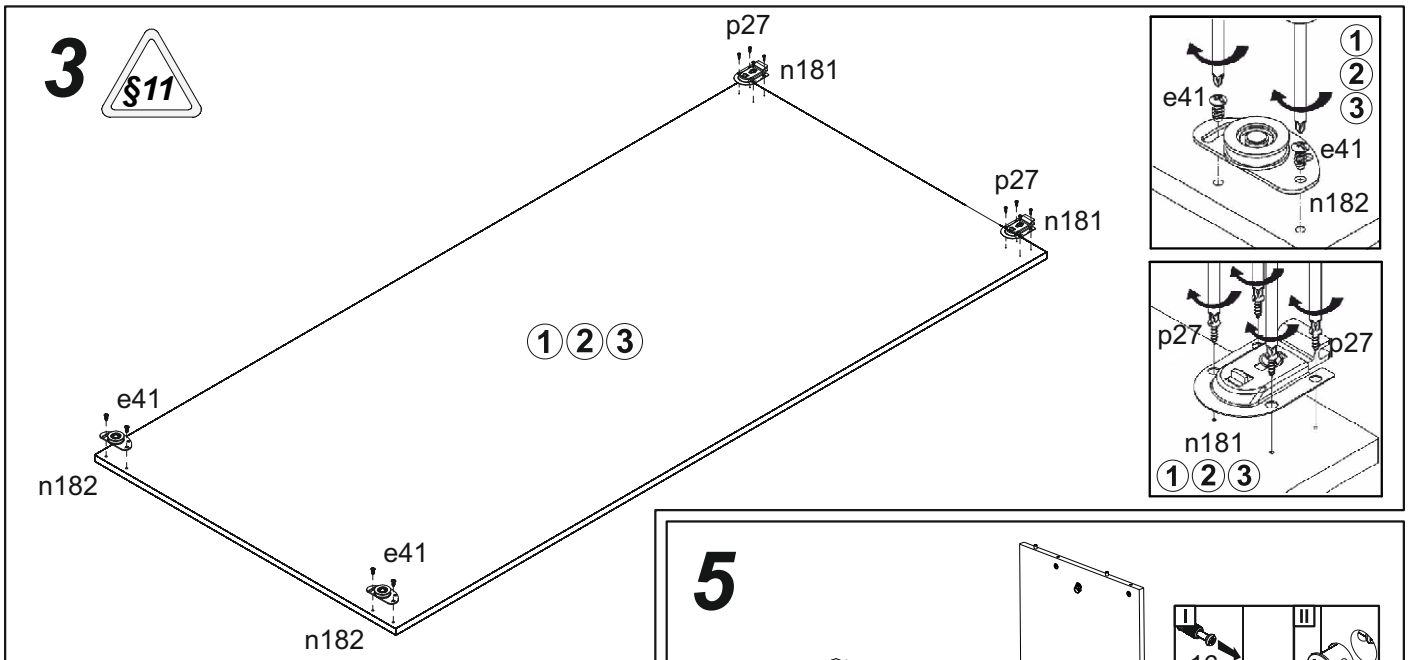
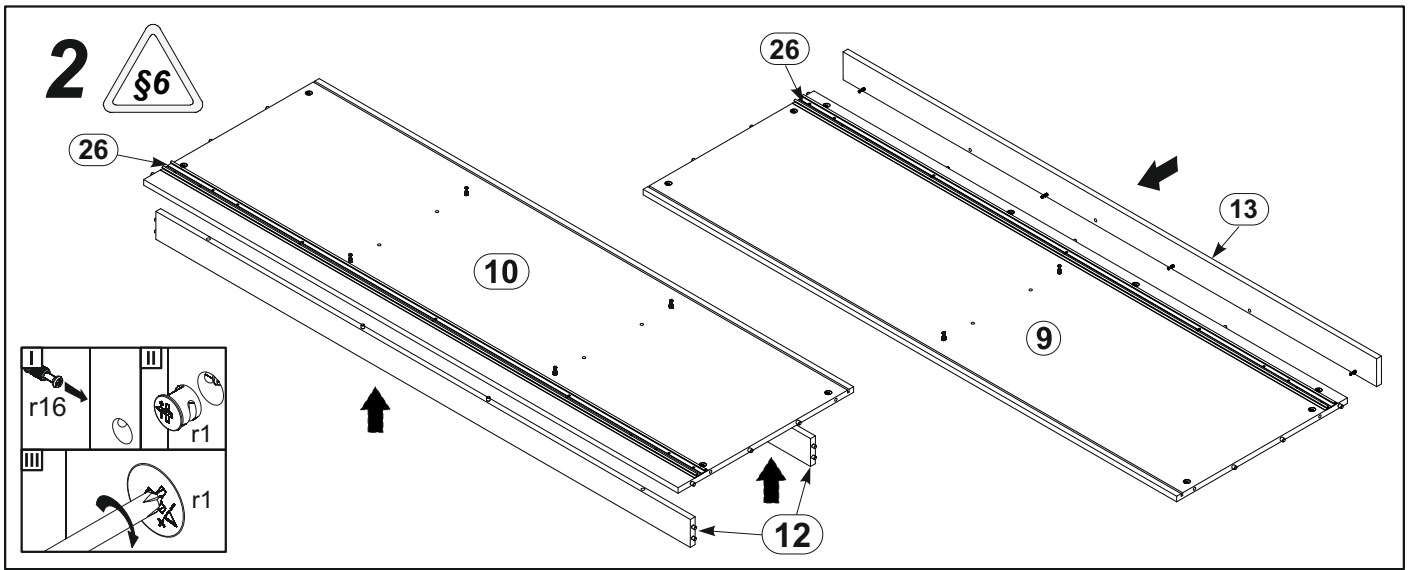

6

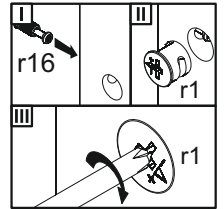
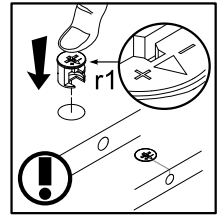
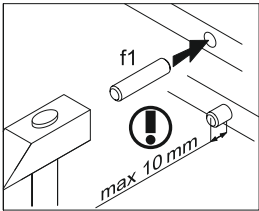
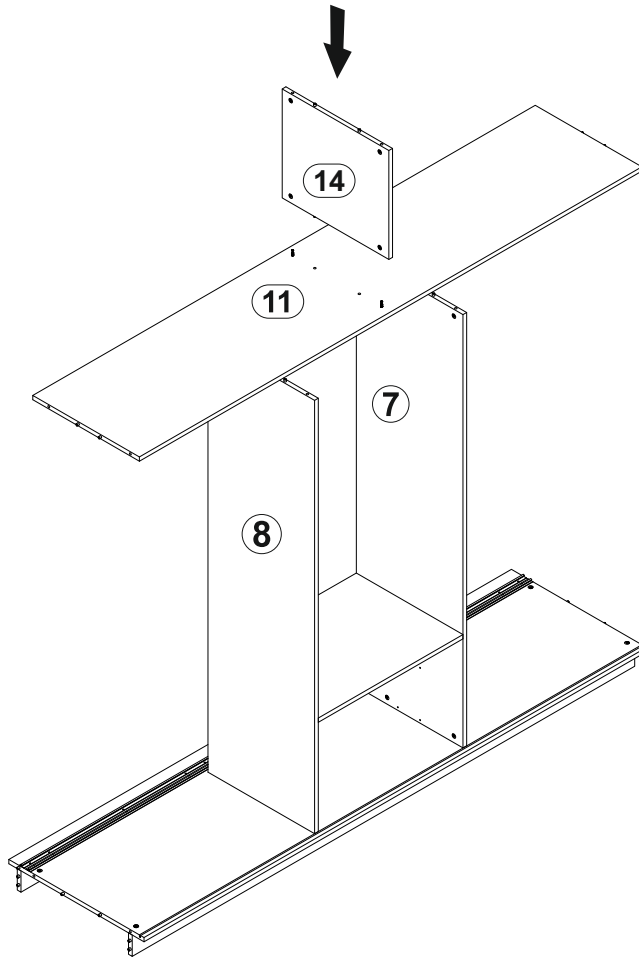
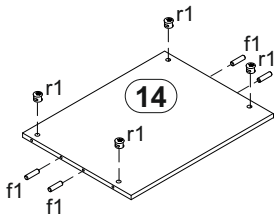

7

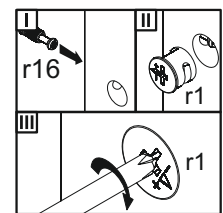
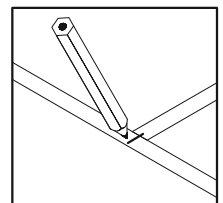
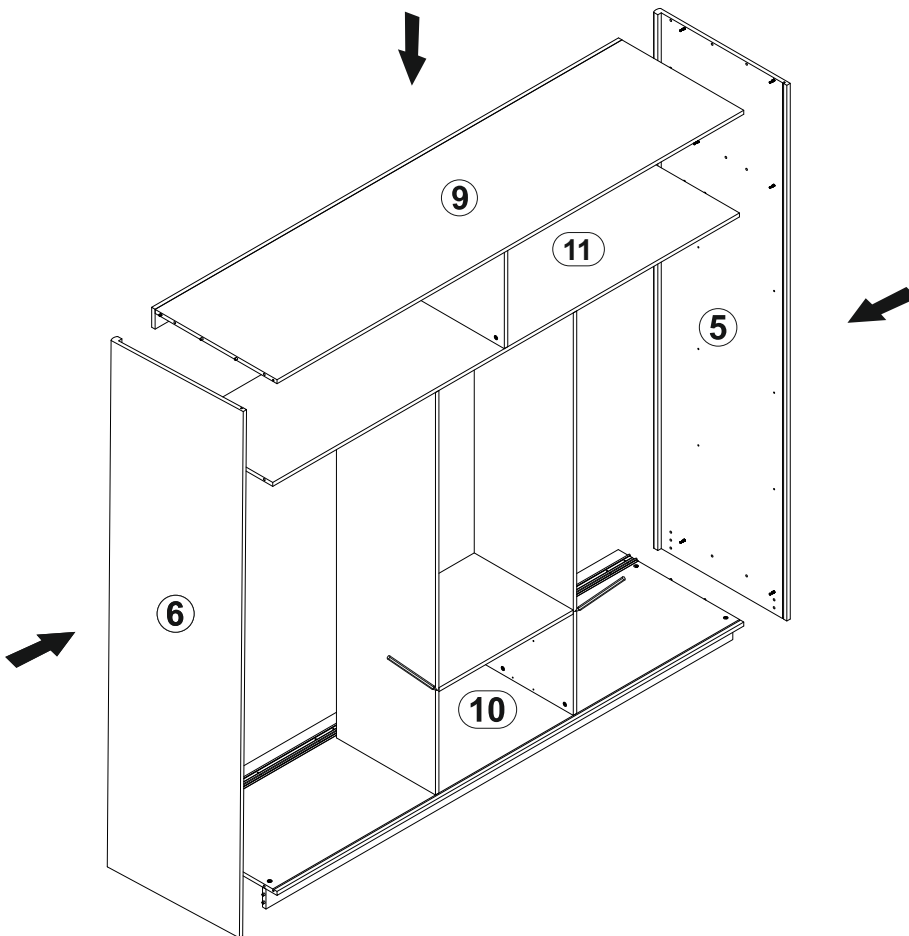

8

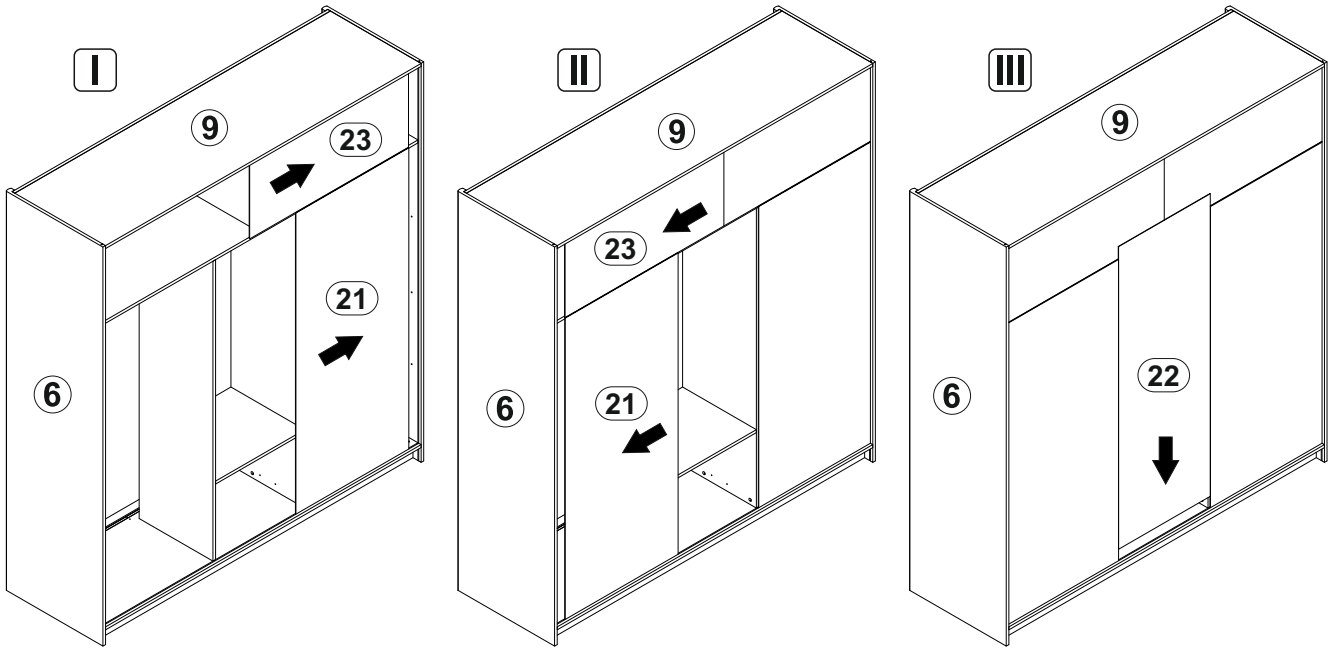

9

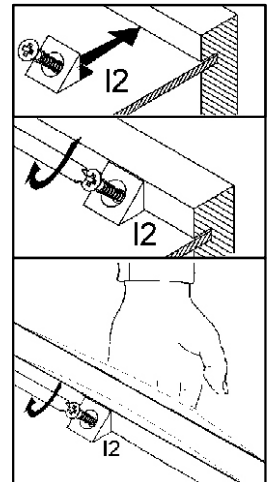
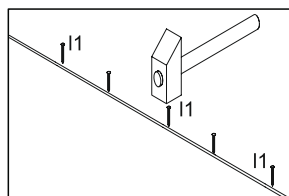
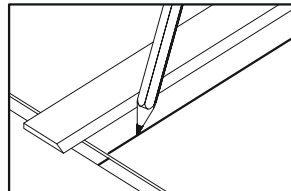
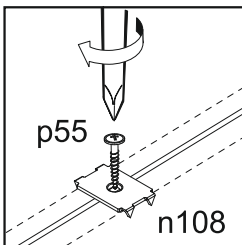
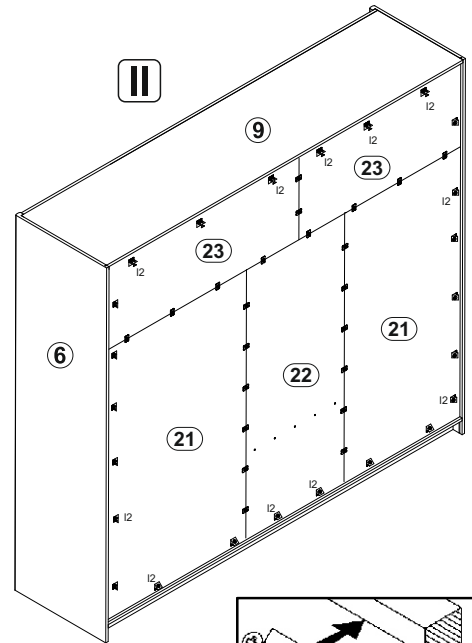
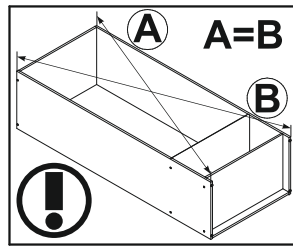
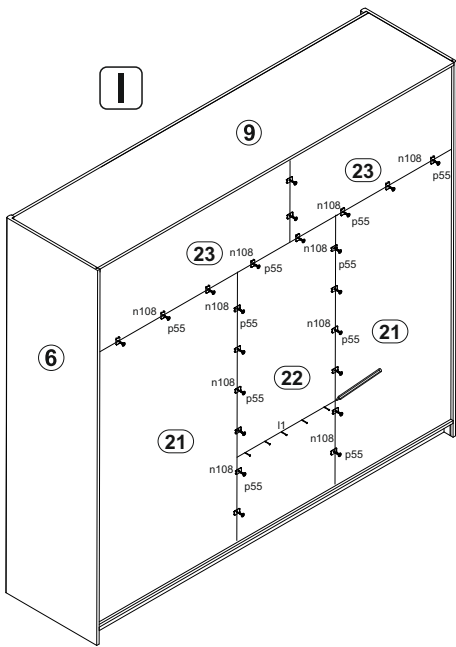

10

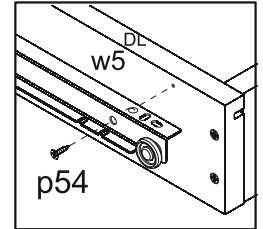
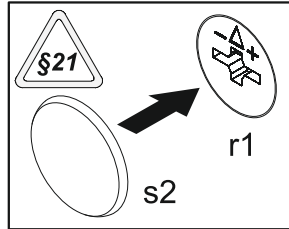
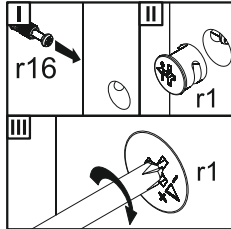
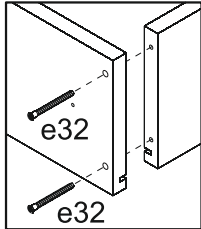
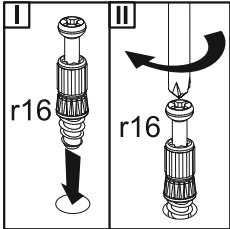
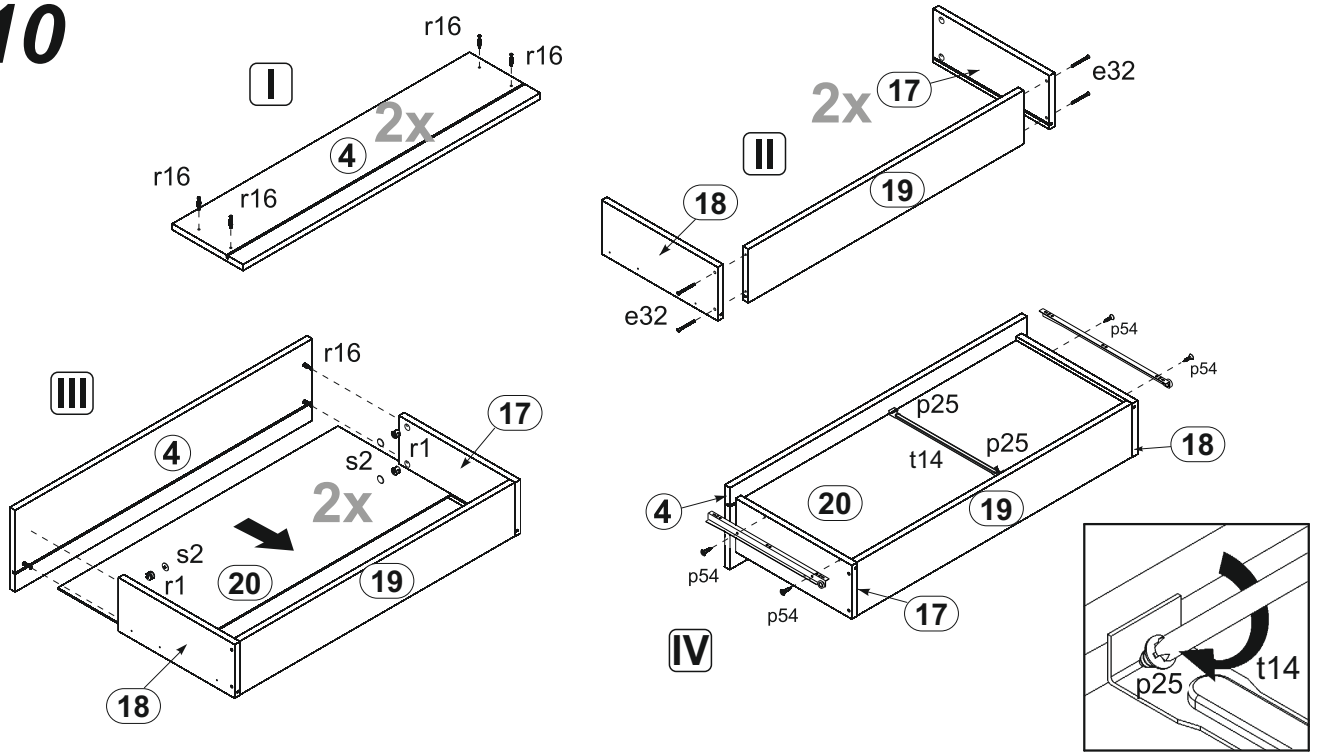

11

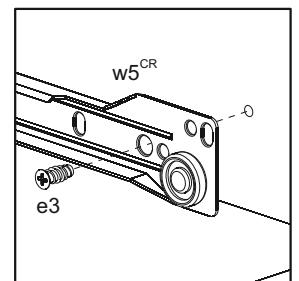
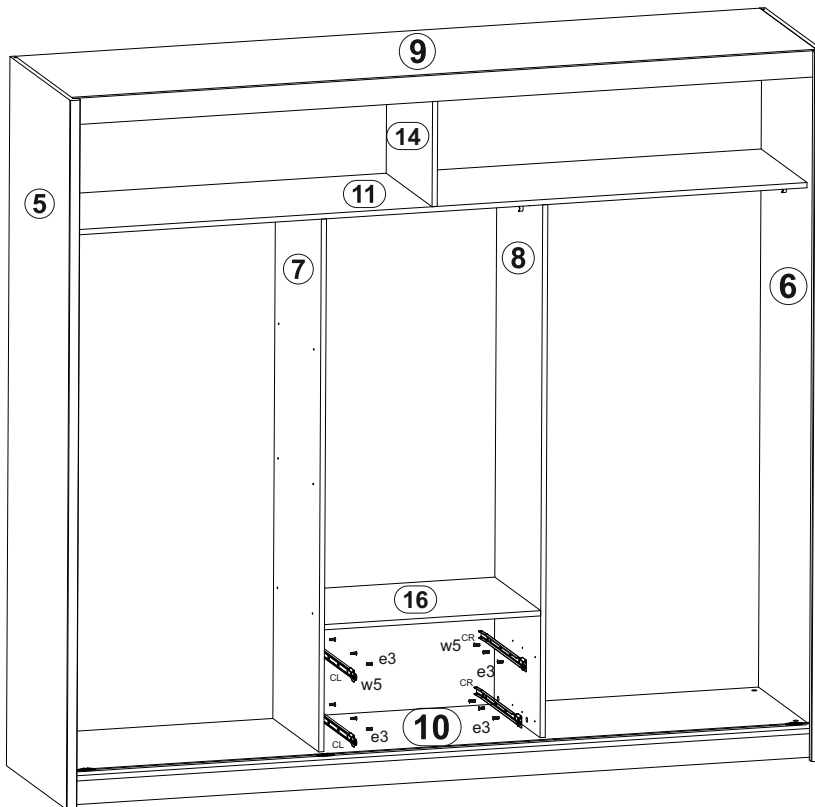

12

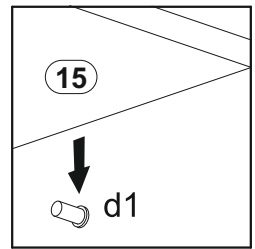
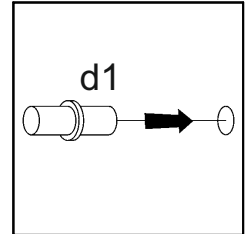
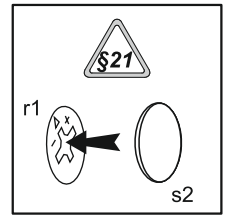
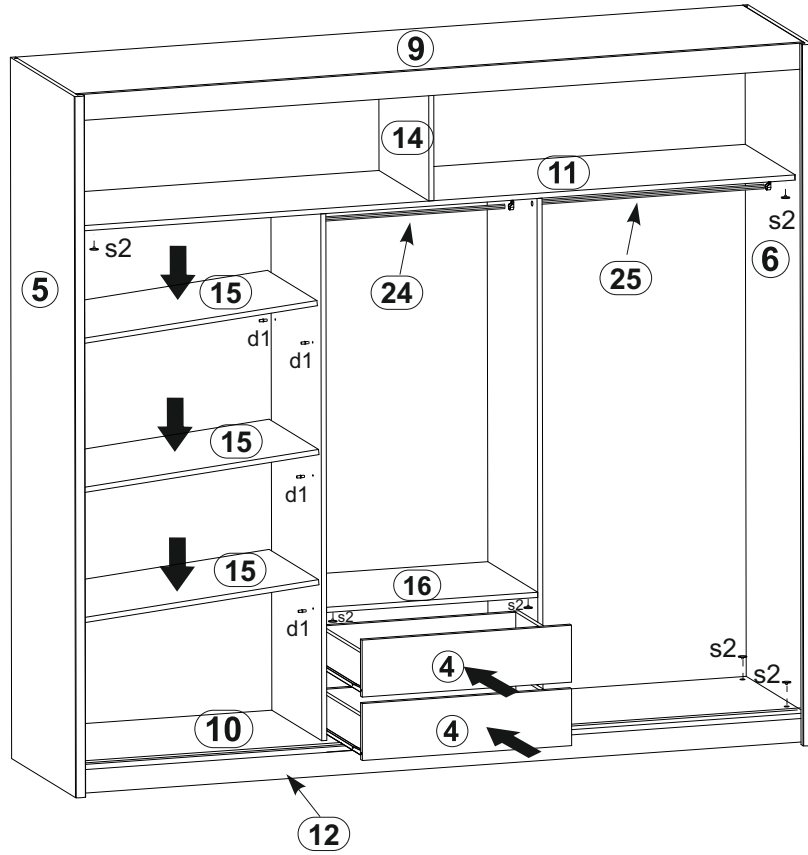
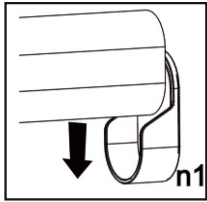

13

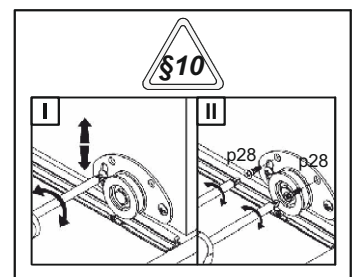
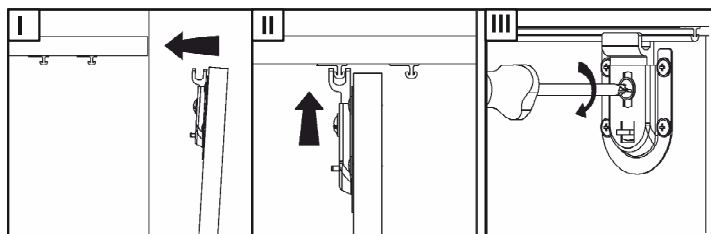
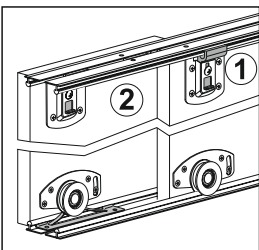
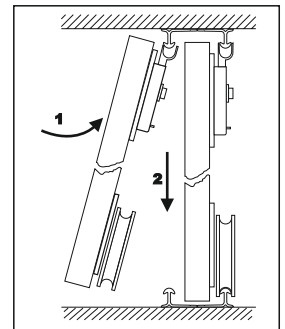
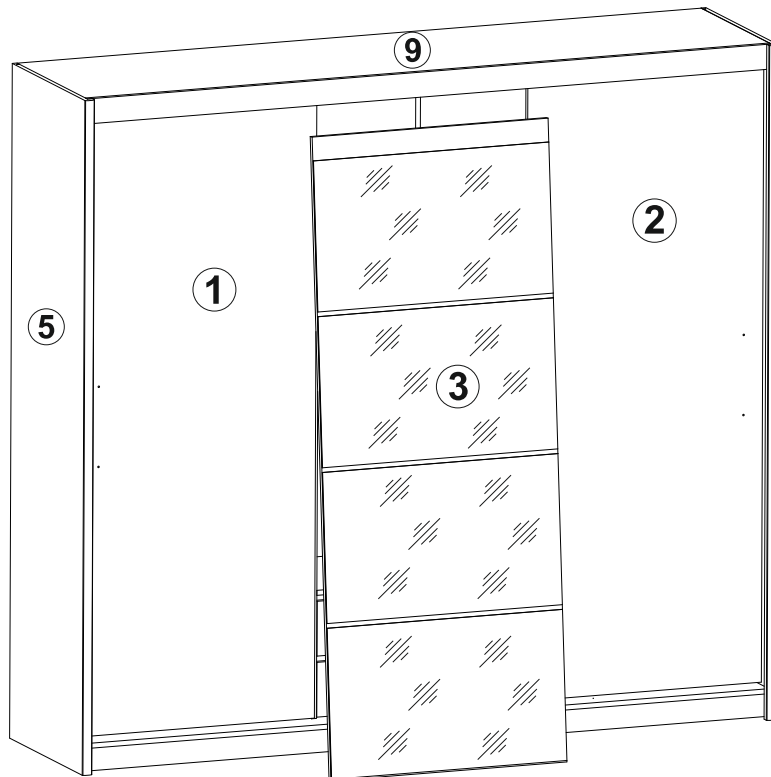

14

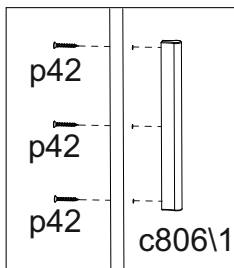
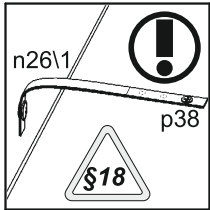
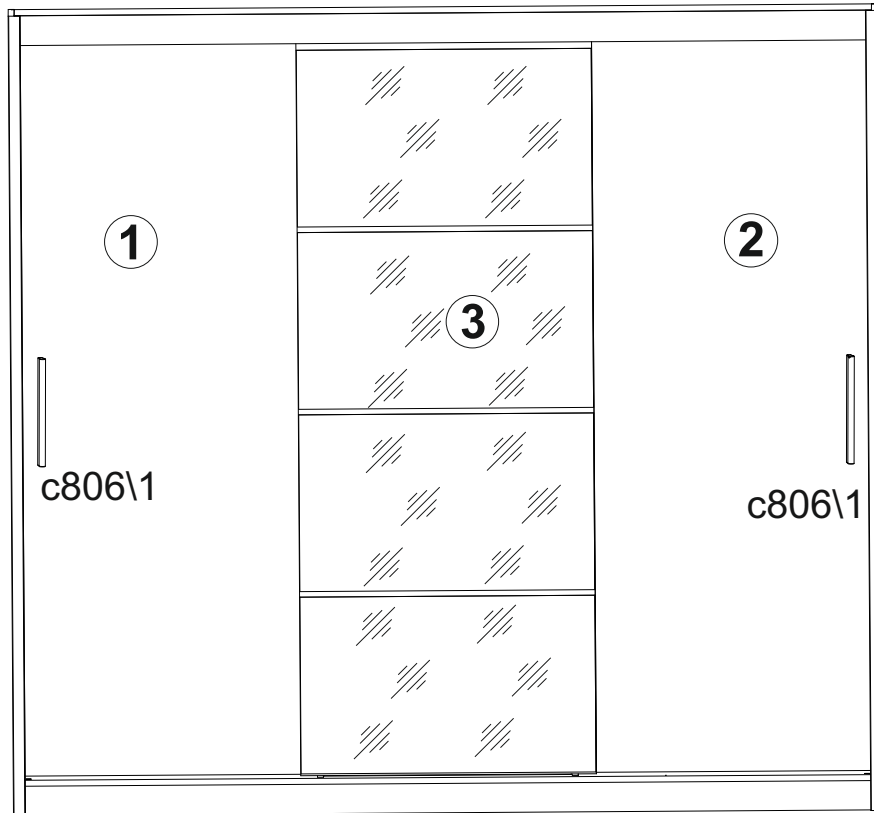

15

