

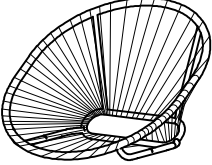













Ax2 	Bx2 	Cx2 	Dx4 			
Ex16  M6*15MM	Fx8  M6*45mm	Gx 32 	Kx8 	Lx24 	Mx8 	Hx1 
Yx1 	Qx1 	Px1 				

"Note: Do not tighten completely until assembly is completed."



STEP1

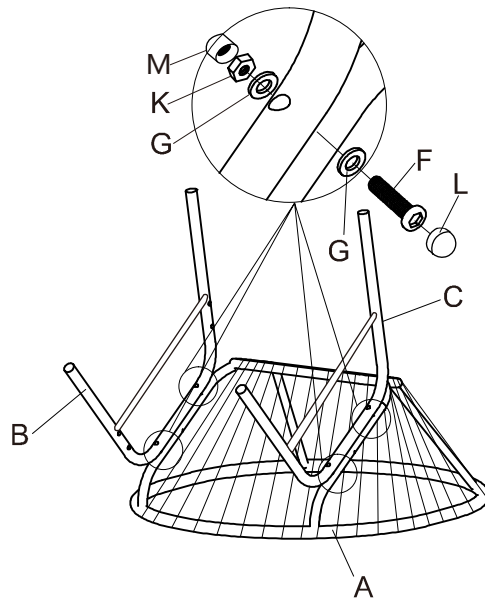

STEP2

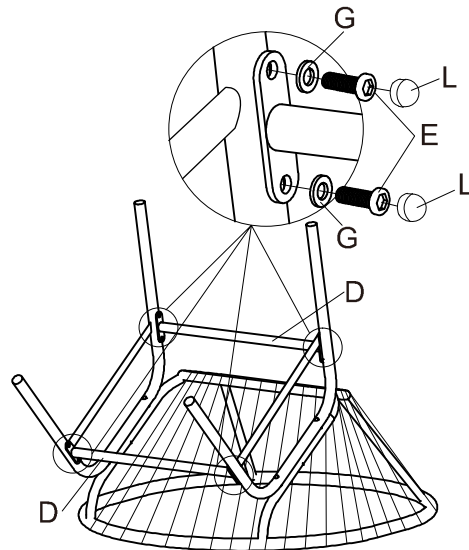

STEP3

