











128-000076

A  1	B  1	C  1	1  1
2  M6x45 4	3  M6x40 4	4  M6 8	5  1
6  1	7  M6 4	/	

STEP1

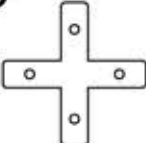

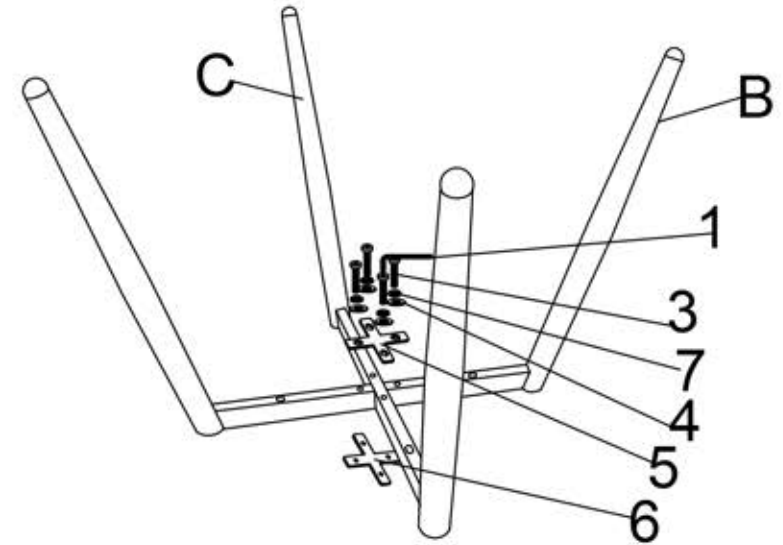
STEP2

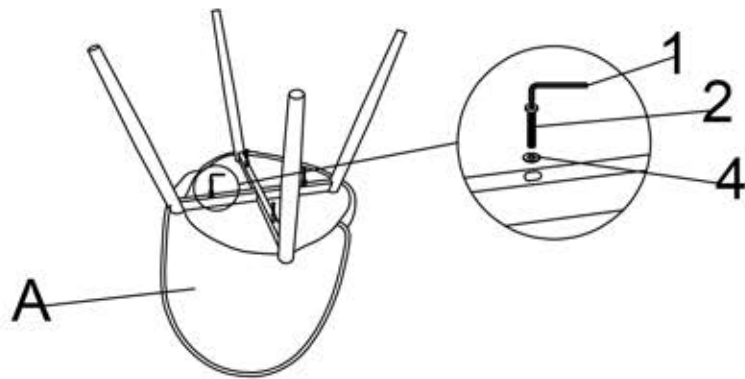

STEP3



Touch me for level!