

ASSEMBLY INSTRUCTION
MODEL : / BOOKCASE

123-000153

Before you begin, please follow assembly instruction carefully.
 Then follow them step by step.

STEP 1

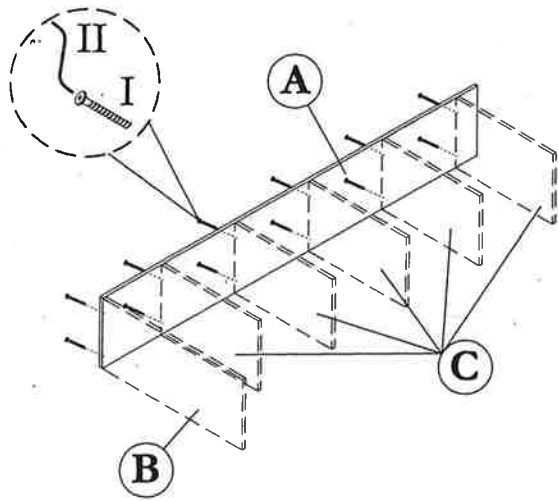

STEP 2

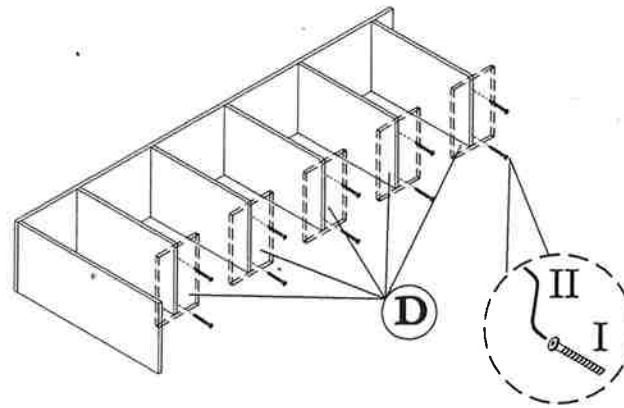

STEP 3

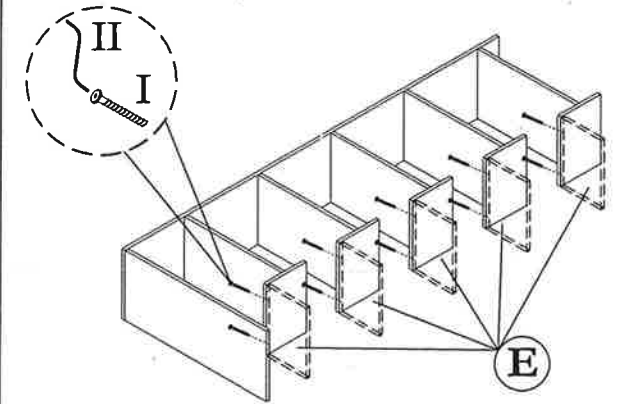

STEP 4

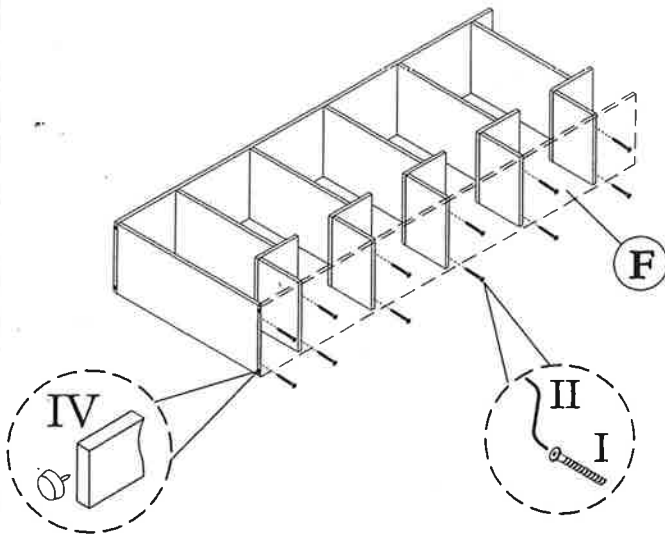

STEP 5

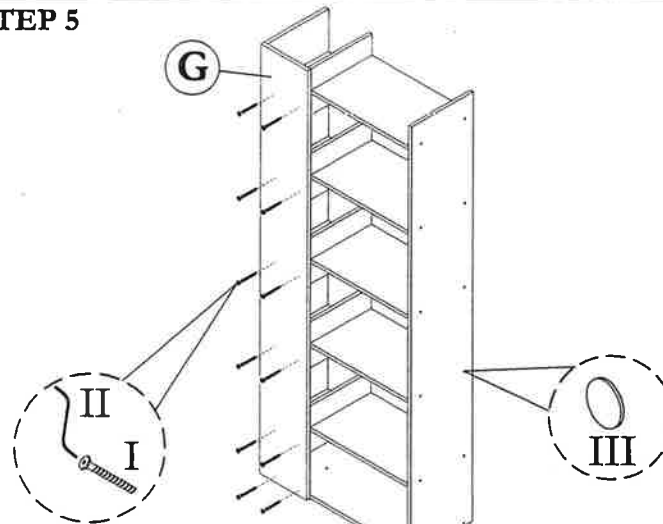

STEP 6

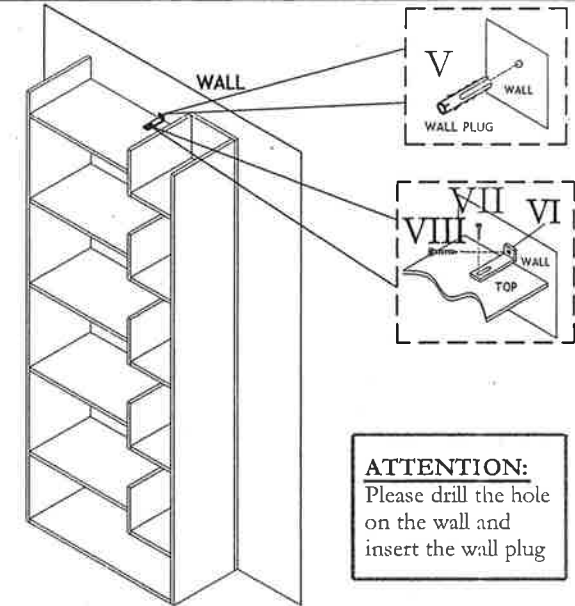

ATTENTION:
 Please drill the hole
 on the wall and
 insert the wall plug

| HARDWARE LIST | | | |
|---------------|-----------------------|--|-------|
| NO | DESCRIPTION | | QTY |
| I | JCBCW SCREW M6.3 x 50 | | 56pcs |
| II | M4 ALLEN KEY | | 1pc |

| | | | |
|-----|-------------------|--|-------|
| III | STICKER | | 34pcs |
| IV | PVC NAIL WITH PIN | | 6pcs |
| V | WALL PLUG | | 1pc |
| VI | L-BRACKET | | 1pc |

| | | | |
|------|-------------------------|--|-----|
| VII | M4 x 16 CHIPBOARD SCREW | | 1pc |
| VIII | M4 x 38 CHIPBOARD SCREW | | 1pc |

CAUTION:

To clean use soft, dry cloth. Do not use detergent or chemicals
Avoid contact with water and direct sunlight.
To be assembled on a soft, dry, clean and smooth surface.

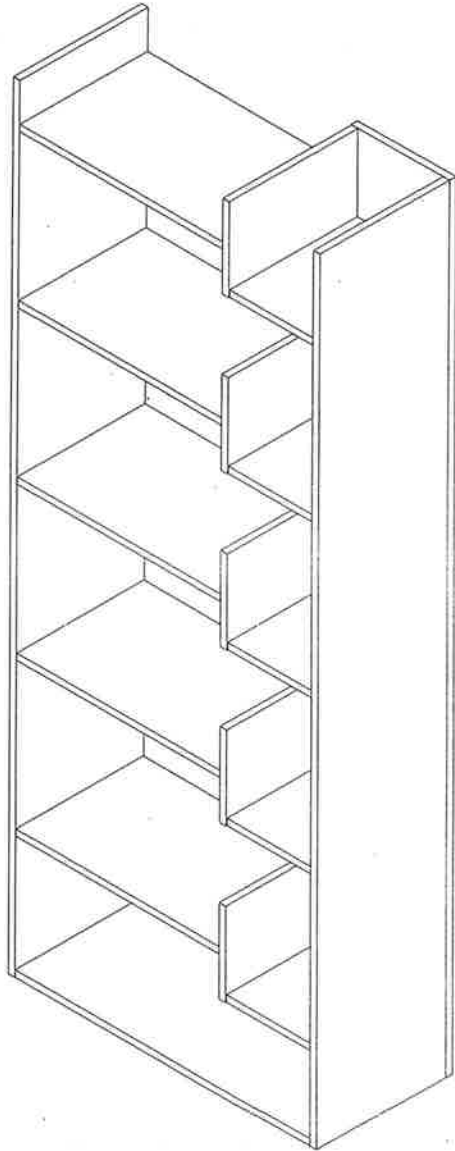

COMPLETE SET

ORDERING REPAIR PARTS

In order to obtain smooth and rapid service when ordering repair parts, please give full attention to the following of PART NUMBER.

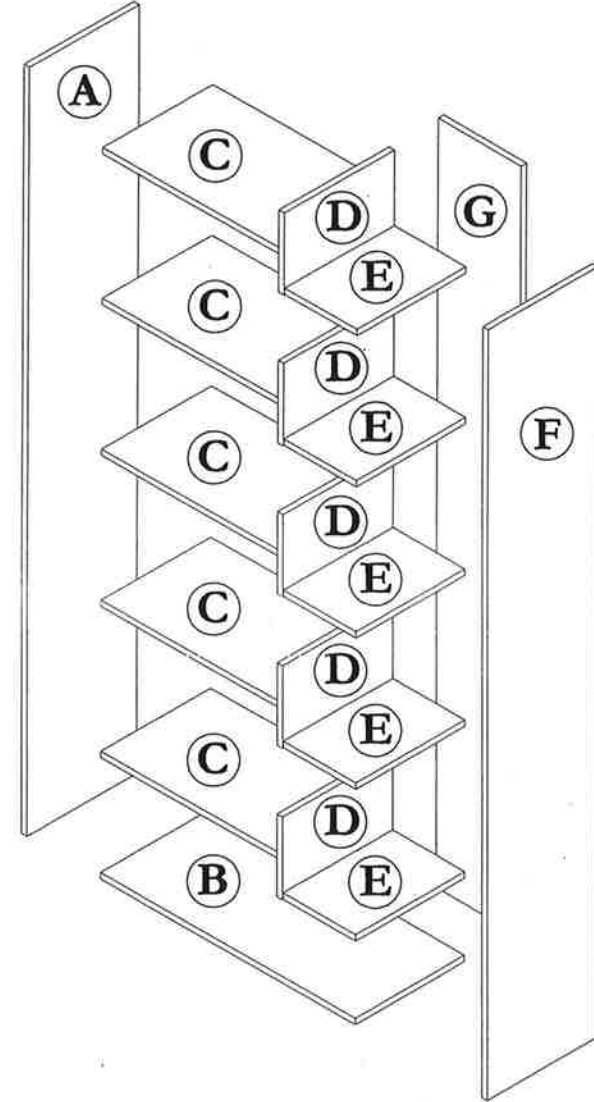

| NO | DESCRIPTION | QTY |
|----|-----------------|-----|
| A | LEFT SIDE | 01 |
| B | LOWER SHELF | 01 |
| C | SHELF | 05 |
| D | CENTRE VERTICAL | 05 |

| NO | DESCRIPTION | QTY |
|----|-------------|-----|
| E | SHELF | 05 |
| F | RIGHT SIDE | 01 |
| G | BACK | 01 |