

---

## ASSEMBLY MANUAL

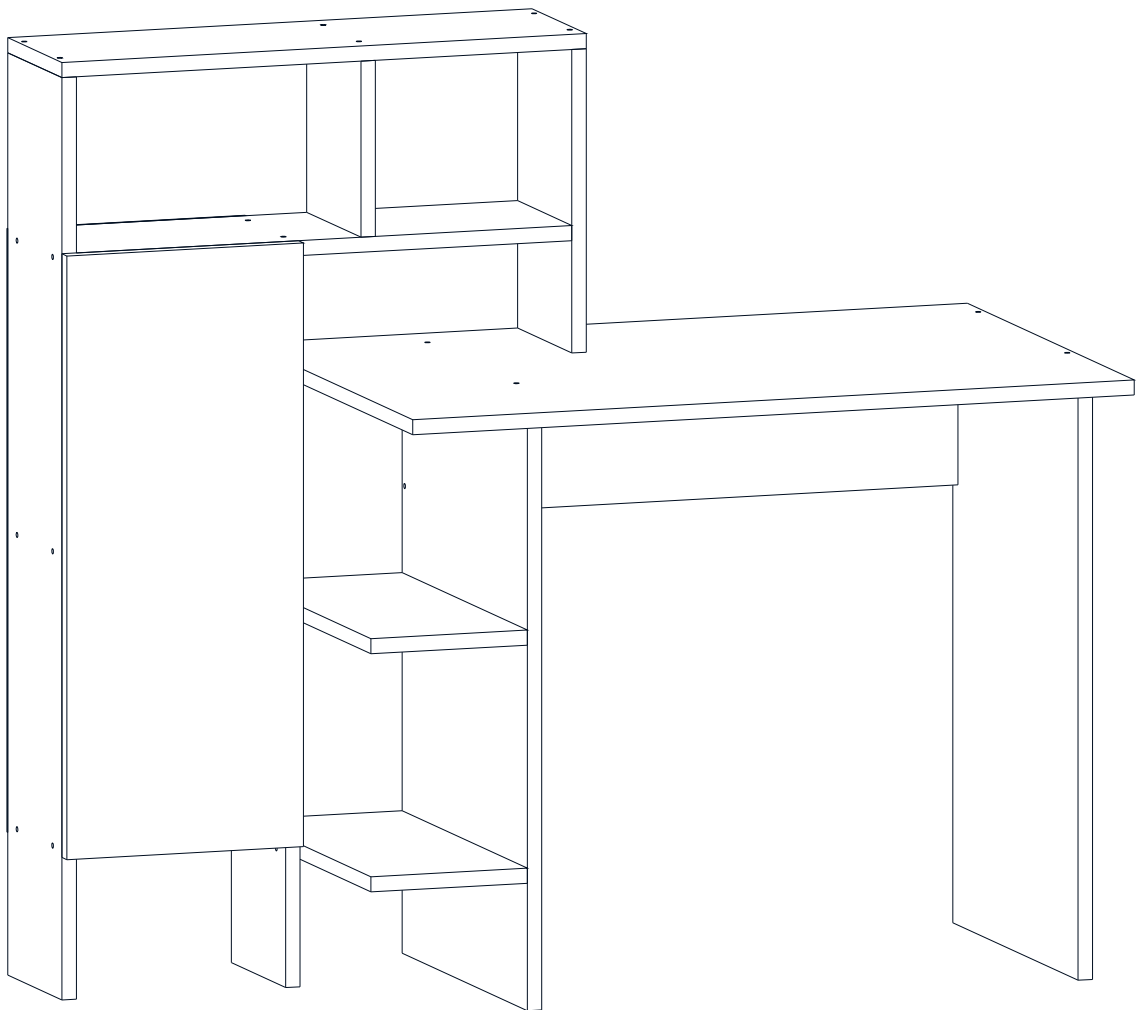

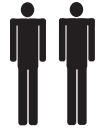



This unit should be assembled by two persons.

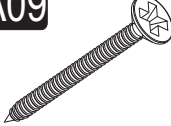
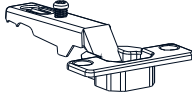
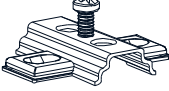

## ACCESSORY LIST

The necessary tools (not included)

<b>A10</b> 3,5x18 YHB Vida  <b>8x</b>	<b>A09</b> 4x50 YHB Vida  <b>42x</b>	<b>A12</b> Düz Mentеше  <b>2x</b>	<b>A13</b> Mentеше Atlığı  <b>2x</b>	<b>A28</b> Arkalık Çivisi  <b>30x</b>
<b>A16</b> Vida Tapa 1. RENK <b>6x</b> 2. RENK <b>36x</b> 				

## GENERAL VIEW

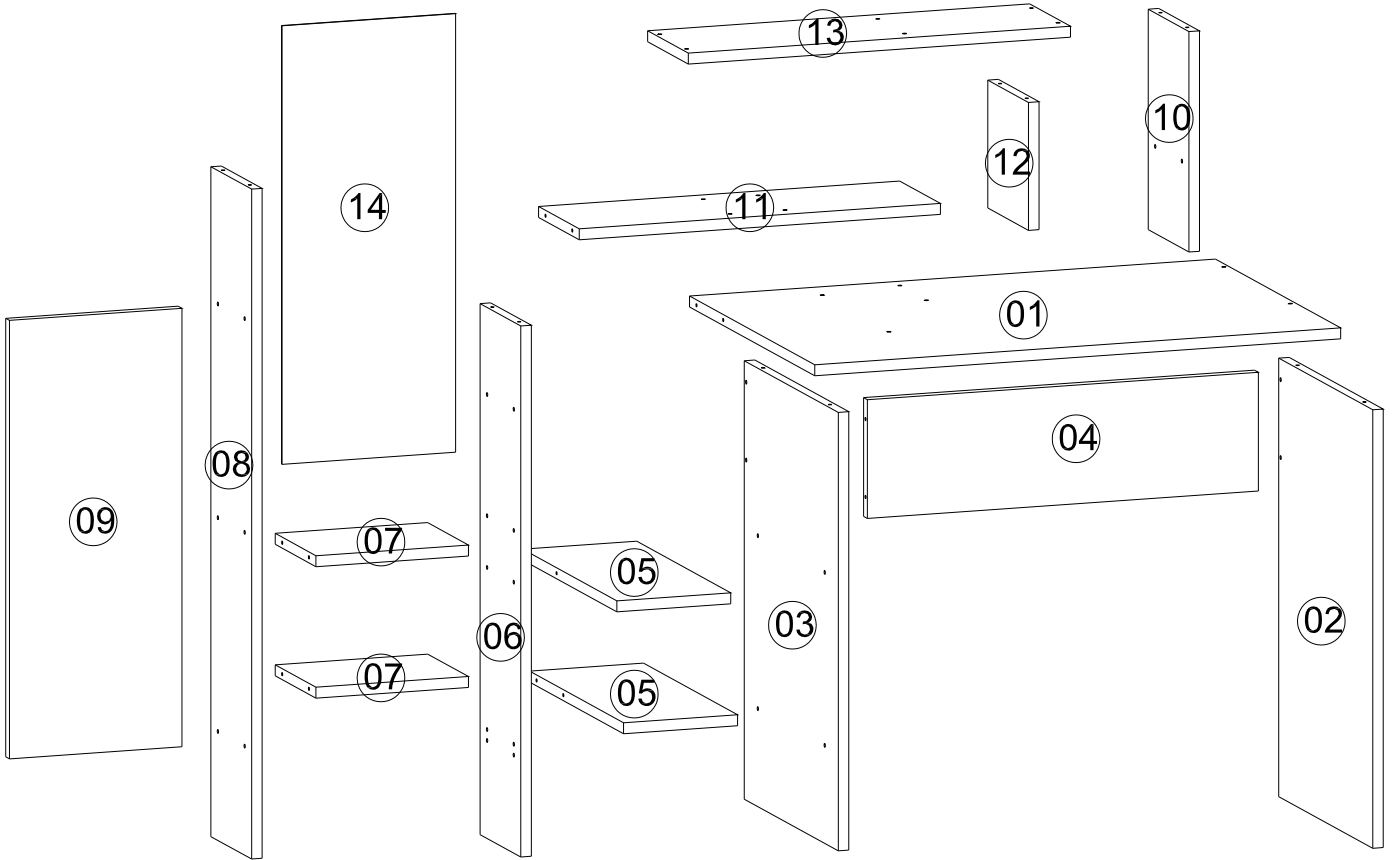

# ASSEMBLY MANUAL

