

ASSEMBLY INSTRUCTION

093-000027

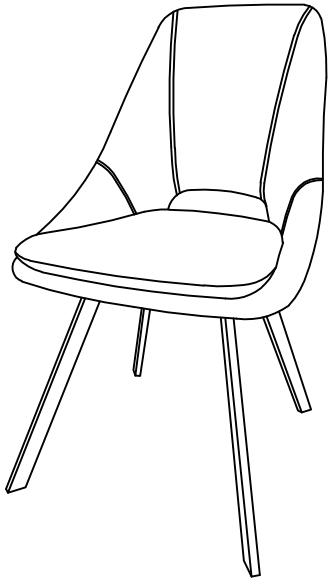

A		1
B		4
C		4
D		2

1

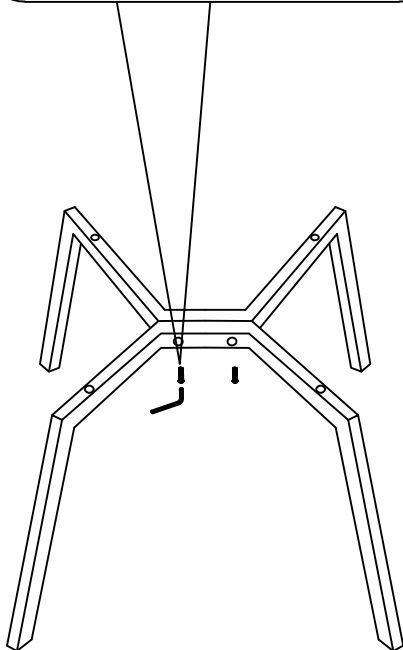
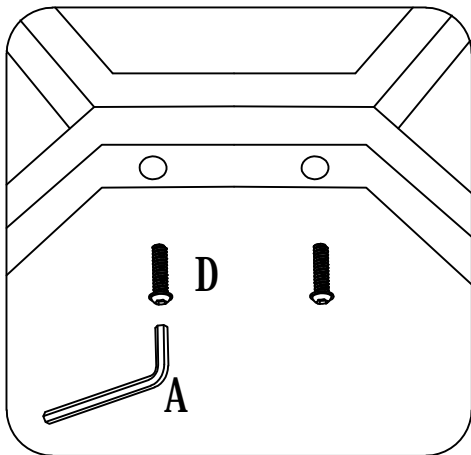

2

