

071-000329

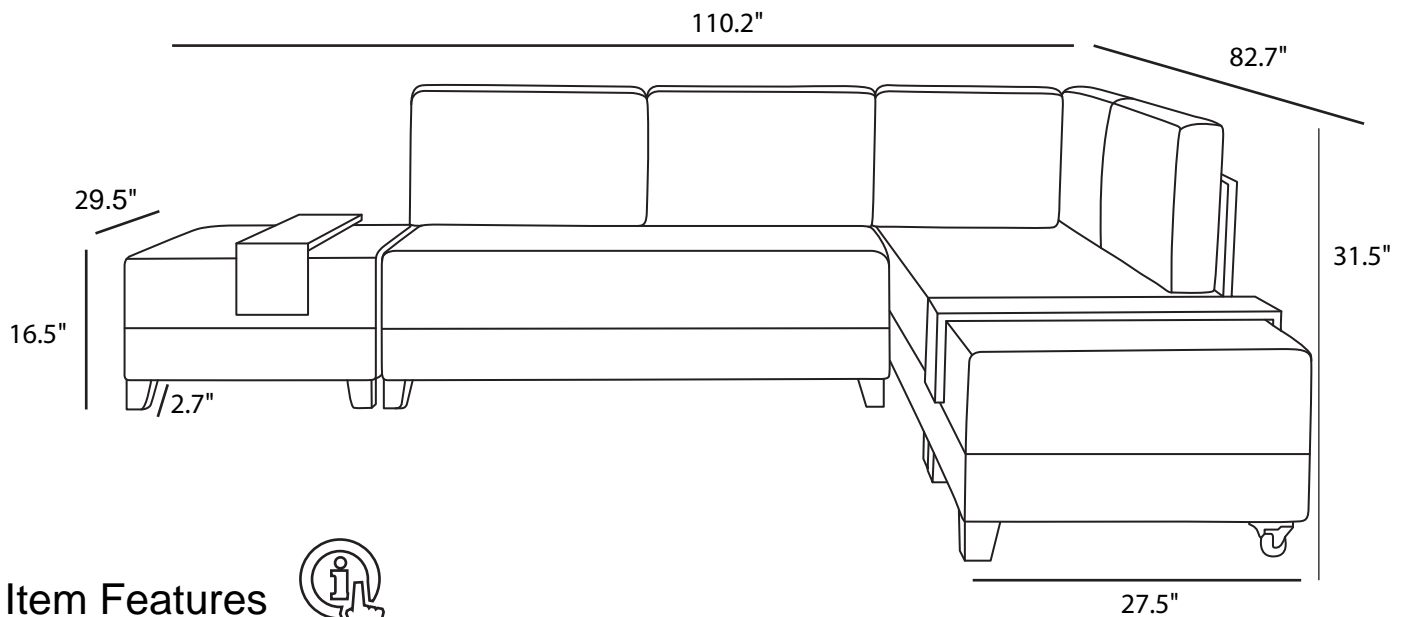

Item Features



- Frame** ★ The product's main interior frame that carries/holds weight and pressure is constructed from hardwood timber while other sections that is not exposed to direct pressure are made from particle board. 100% solid timber is used to support the main carrier sections where legs are installed.
- Legs** ★ Legs are made of high carrier capacity hard plastic.
- Cushions** ★ The sofa seat cushions are filled with 4.7" (12 cm) thick 32 density soft gray foam.
- Pillows** ★ Pillows are filled with a particle foam.
- Fabric** ★ Easy to clean, woven polyester and cotton blend fabric is used for upholstery.
- Health & Safety** ★ Manufactured from human health and environment friendly materials.
- Assembly** ★ The legs and back parts of the product are shipped disassembled. You should place the back pieces by pushing till the end of the channel we created. There are two back and one corner pieces that need to be installed on the product base. Poufs are connected to the corners with connectors. You need to connect one side of the fastener, the other side comes pre installed. You can assemble the product using a
- Installation** ★ Power drill is enough to install legs.
- Package includes** ★ Legs and installation hardware come with the package.

Proper Usage









- ✓ Do not expose the item to sunlight directly. Direct sunlight may cause fading of the color.
- ✓ Please protect upholstery fabric from sharp objects, glue, hot objects, fire and chemical materials.
- ✓ For a better look of your cushions, you can turn them upside down once a week.

Cleaning

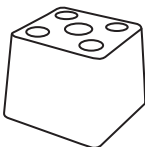

- ✗ First, clean your furniture with vacuum cleaner.
- ✗ Please put some pure soap in a bucket of warm water. Make sure that the soap is fully dissolved in the warm water
- ✗ Before cleaning your furniture, try a test clean in a small area on the back of the seat cushion first.
- ✗ Please wait until cushions and pillows are fully dried.

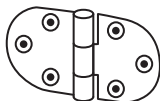
Part List

<p>A: </p>	<p>B: </p>	<p>C: </p>	<p>D: </p>	<p>E: </p>	<p>F: </p>
<p>Plastic Leg 12 pieces</p>	<p>Lockable Castor Wheel 4 pieces</p>	<p>4x35 Screw 28 pieces</p>	<p>5x50 Screw 48 pieces</p>	<p>Pouf Butt Hinge 2 pieces</p>	<p>Arm Stand Box 1 piece</p>

