

A	1800x350	1/3
B	1800x350	1/3
C	470x350	3/3
D	2x 558x350	3/3
E	558x350	3/3
F	4x 558x330	1,3/3
G	271x330	3/3
H	558x80	3/3
I	2x 1715x292	2/3
J	2x 1717x292	2/3

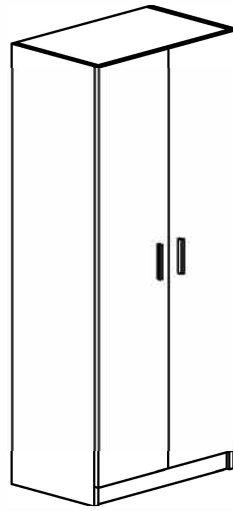

16x 10174 Φ 8/30	20x 10013	16x 50317	6x 40158	2x 20108	4x 50738	2x 51066
2x 10060	20x 50332 Φ 6/80	2x 10021 Φ 4/30	4x 10006 Φ 3,5/16	29x 10001		

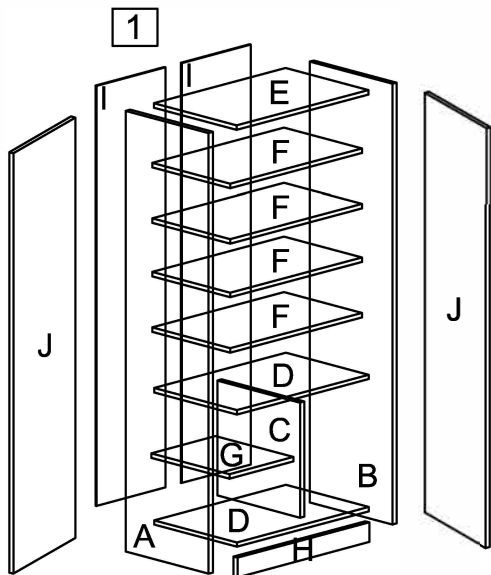

(V1)

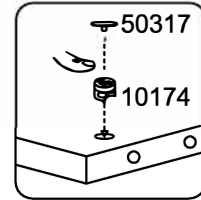
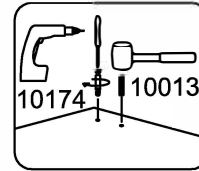

1.1

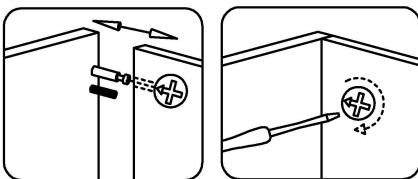
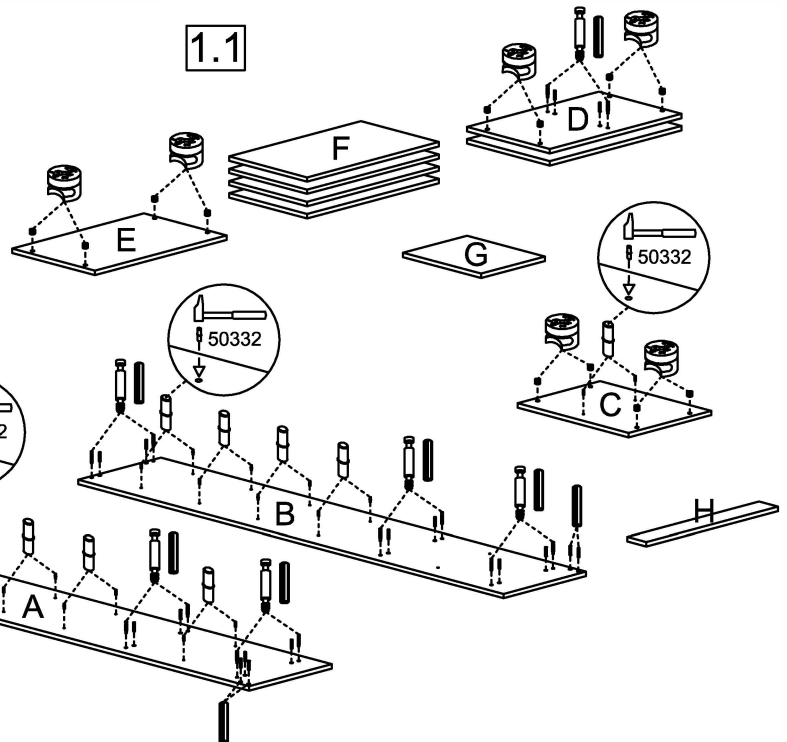

1.2

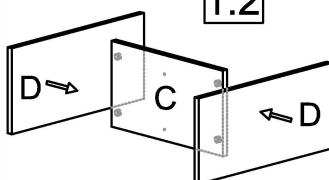

1.3

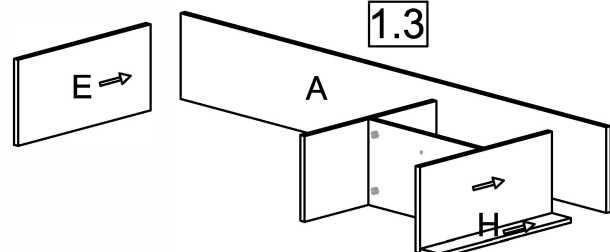

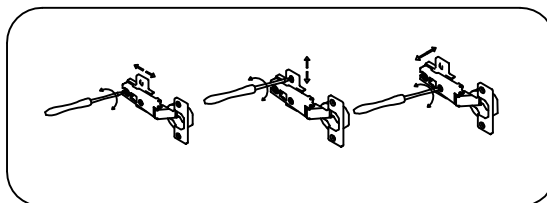
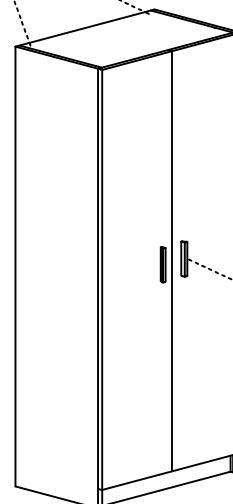
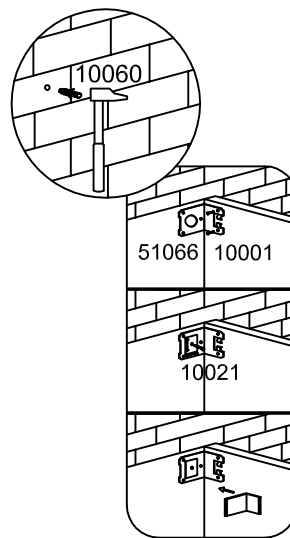
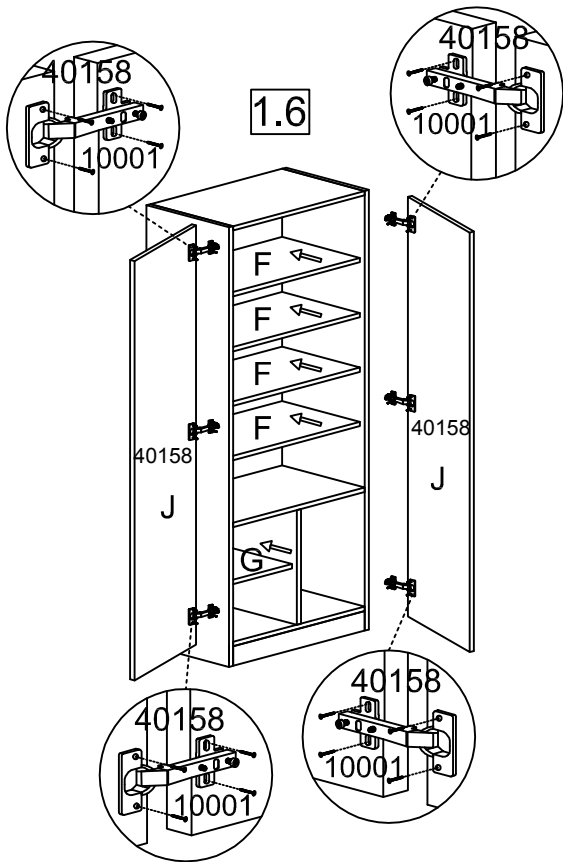
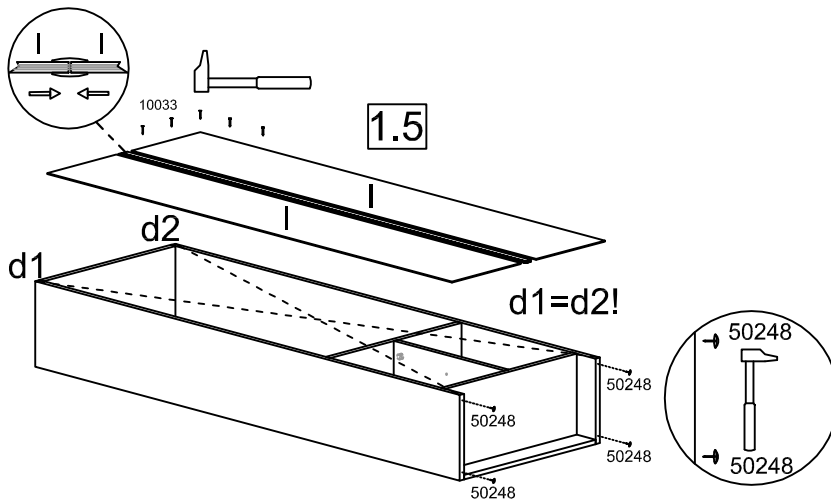
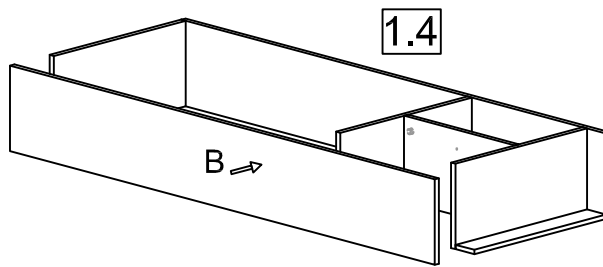
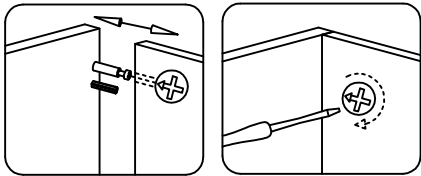

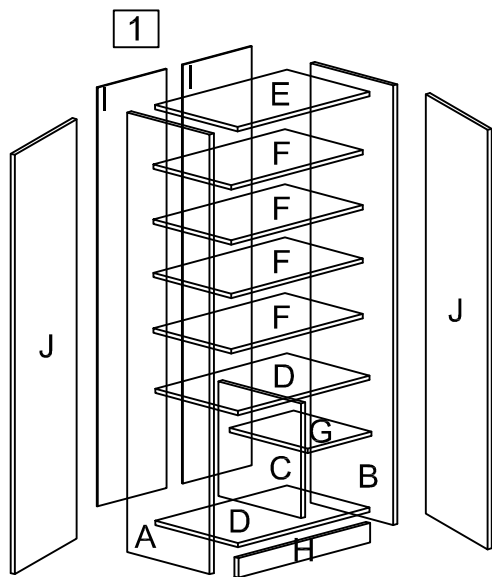

V2

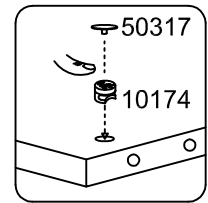
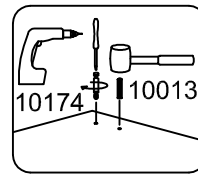

1.1

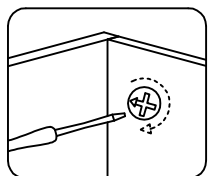
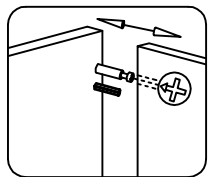
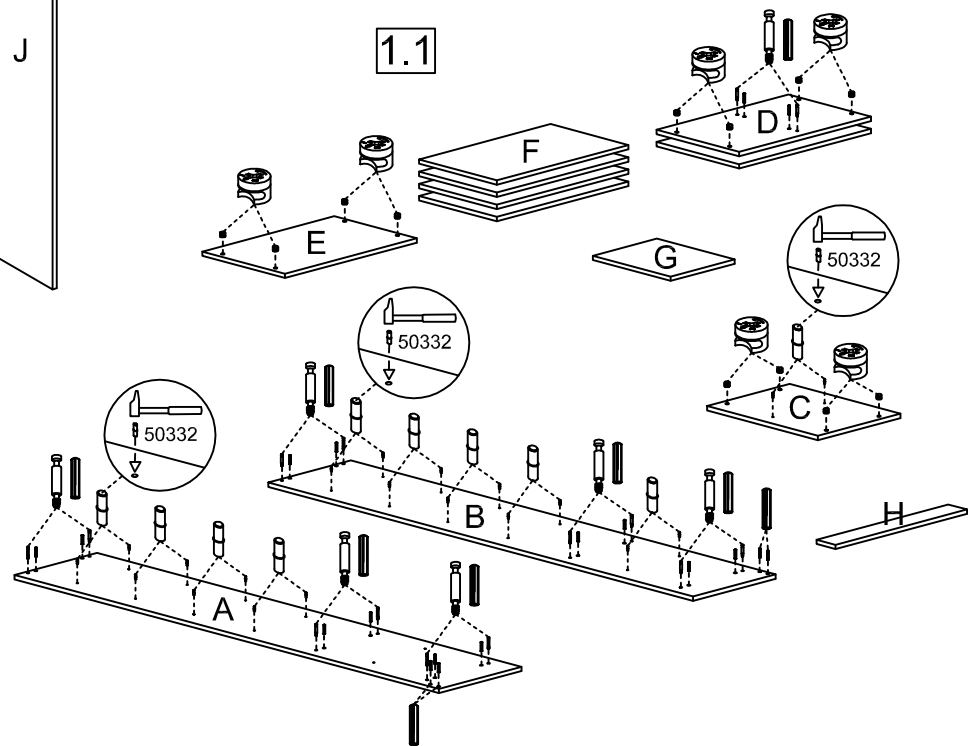

1.2

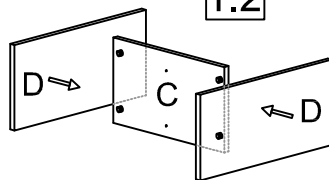

1.3

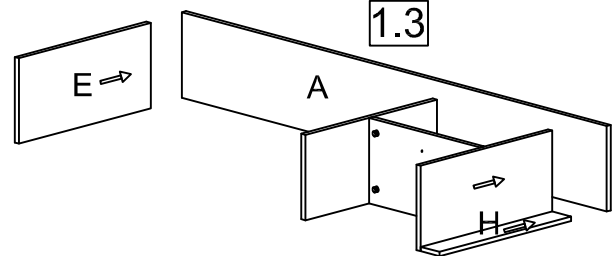

1.4

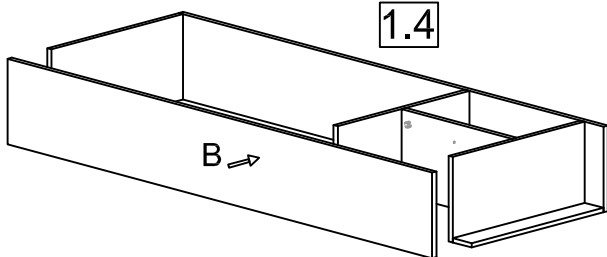

1.5

