

039-000177

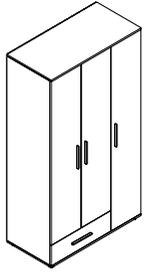

EN AZ İKİ KİŞİ İLE KURUNUZ!



TWO PERSON ASSEMBLY REQUIRED!

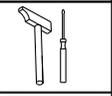

Rev. 00 / 14.07.2021

**TR:** Keyifli ve kolay bir montaj için: Garanti şartlarının geçerli olması için kurulum şemasındaki sıraya uygun olarak montaj yapılması gerekmektedir. Hatasız ve daha kolay montaj için tüm parçaları önce geniş ve düz zemine diziniz. Şemada gösterilen parça listesi ile ürün kutusundan çıkan parçaları karşılaştırınız. Montajı ürün kolisi üzerinde veya sert ve çizici olmayan bir zeminde, parça kutusundan çıkan "L" şeklindeki demir çubuk (alyan anahtarı), yıldız tornavida ve çekici kullanara yapınız. Kurulumu tamamladıktan sonra montaj şemasını saklayınız.

**EN:** For an easy and enjoyable assembly: Please read the assembly chart completely. Remove all the parts from the carton box and place them on a smooth surface. Make sure you have exactly all the parts and tools listed in on the chart ready. Start assembling the products following the steps on the chart. Use only the tools provided within the product, a screwdriver and a hammer. Please keep the assembly chart for future reference.

**DE:** Für eine einfache und unterhaltsame Montage: Bitte lesen Sie die Montagetabelle vollständig durch. Entfernen Sie alle Teile aus der Kartonverpackung und legen Sie sie auf eine glatte Oberfläche. Stellen Sie sicher, dass Sie genau alle Teile und Werkzeuge bereit haben, die in der Tabelle aufgeführt sind. Beginnen Sie mit der Montage der Produkte gemäß den Schritten in der Tabelle. Verwenden Sie nur die im Produkt enthaltene Werkzeuge sowie einen Schraubendreher und einen Hammer. Bitte bewahren Sie die Montagetabelle zum späteren Nachschlagen auf.

**FR:** Pour un montage simple et facile: Veuillez lire l'intégralité du manuel de montage. Retirez toutes les pièces de l'emballage et placez-les sur une surface lisse. Assurez-vous d'avoir toutes les pièces et tous les outils répertoriés dans le manuel de montage. Commencez à assembler les pièces en suivant les étapes du manuel. Utilisez uniquement les outils fournis avec le produit, un tournevis et un marteau. Veuillez conserver précieusement le manuel de montage.

**ES:** Para un montaje fácil y agradable: Por favor, lea la tabla de montaje por completo. Retire todas las piezas del embalaje de la caja de cartón y colóquelas sobre una superficie lisa. Asegúrese de tener listas todas las piezas y herramientas enumeradas en la tabla. Comience a ensamblar los productos siguiendo los pasos en la tabla. Use solo las herramientas proporcionadas dentro del producto y un destornillador y un martillo. Guarde la tabla de ensamblaje para referencia futura.

**IT:** Per un assemblaggio facile e divertente: Si prega di leggere completamente la tabella di montaggio. Rimuovere tutte le parti dall'imballaggio della scatola di cartone e posizionarle su una superficie liscia. Assicurarsi di avere esattamente tutte le parti e gli strumenti elencati nella tabella pronti. Inizia ad assemblare i prodotti seguendo i passaggi sulla tabella. Utilizzare solo gli strumenti forniti all'interno del prodotto e un cacciavite e un martello. Conservare la tabella di assemblaggio per riferimenti futuri.

**GR:** Για εύκολη και ευχάριστη συναρμολόγηση: Παρακαλούμε διαβάστε πλήρως το διάγραμμα συναρμολόγησης. Αφαιρέστε όλα τα εξαρτήματα από τη συσκευασία του κιβωτίου και τοποθετήστε τα σε μια ομαλή επιφάνεια. Βεβαιωθείτε ότι έχετε έτοιμα όλα τα μέρη και τα εργαλεία που αναγράφονται στο γράφημα. Εκινήστε τη συναρμολόγηση των προϊόντων ακολουθώντας τα βήματα του γραφήματος. Χρησιμοποιείτε μόνο τα εργαλεία που παρέχονται μέσα στο προϊόν και ένα κτσαβίδι και ένα σφυρί. Διατηρήστε το διάγραμμα συναρμολόγησης για μελλοντική αναφορά.

**RO:** Pentru o asamblare ușoară și plăcută: Vă rugăm să citiți graficul de asamblare complet. Scoateți toate părțile din ambalajul cutiei de carton și așezați-le pe o suprafață netedă. Asigurați-vă că aveți exact toate piesele și instrumentele enumerate în grafic. Începeți asamblarea produselor urmând pașii din grafic. Folosiți numai instrumentele furnizate în interiorul produsului și o surubelniță și un ciocan. Vă rugăm să păstrați diagrama de asamblare pentru referințe viitoare.

**RU:** Для легкого и приятного монтажа: Пожалуйста, прочитайте инструкции по установке полностью. Удаляйте все части из картонной коробки и поместите их на ровную поверхность. Пожалуйста, убедитесь, что у вас есть ровно все указанных части и инструменты на инструкции по установке готовы. Начните сборку деталей выполнив следующие действия на инструкции по установке. Используйте только входящий в комплект инструментов в помощью отвертки и молотка. Пожалуйста, держите инструкцию по установке для дальнейшего использования.

**ARB:** من أجل تركيب بسيط و ممتع الرجاء قراءة ورقة التركيب بكاملها تخليّة جميع القطع من العلبة الكارتون و وضعهم على سطح أملس حضر جميع القطع و الأجهزة المطلوبة في القائمة بكاملها المتعمل فقط الأجهزة المتوفرة مع المنتج بلاضافة الى المطرقة و مفك البراغي الرجاء الاحتفاظ بأوراق التركيب لاستعمالها في وقت لاحق

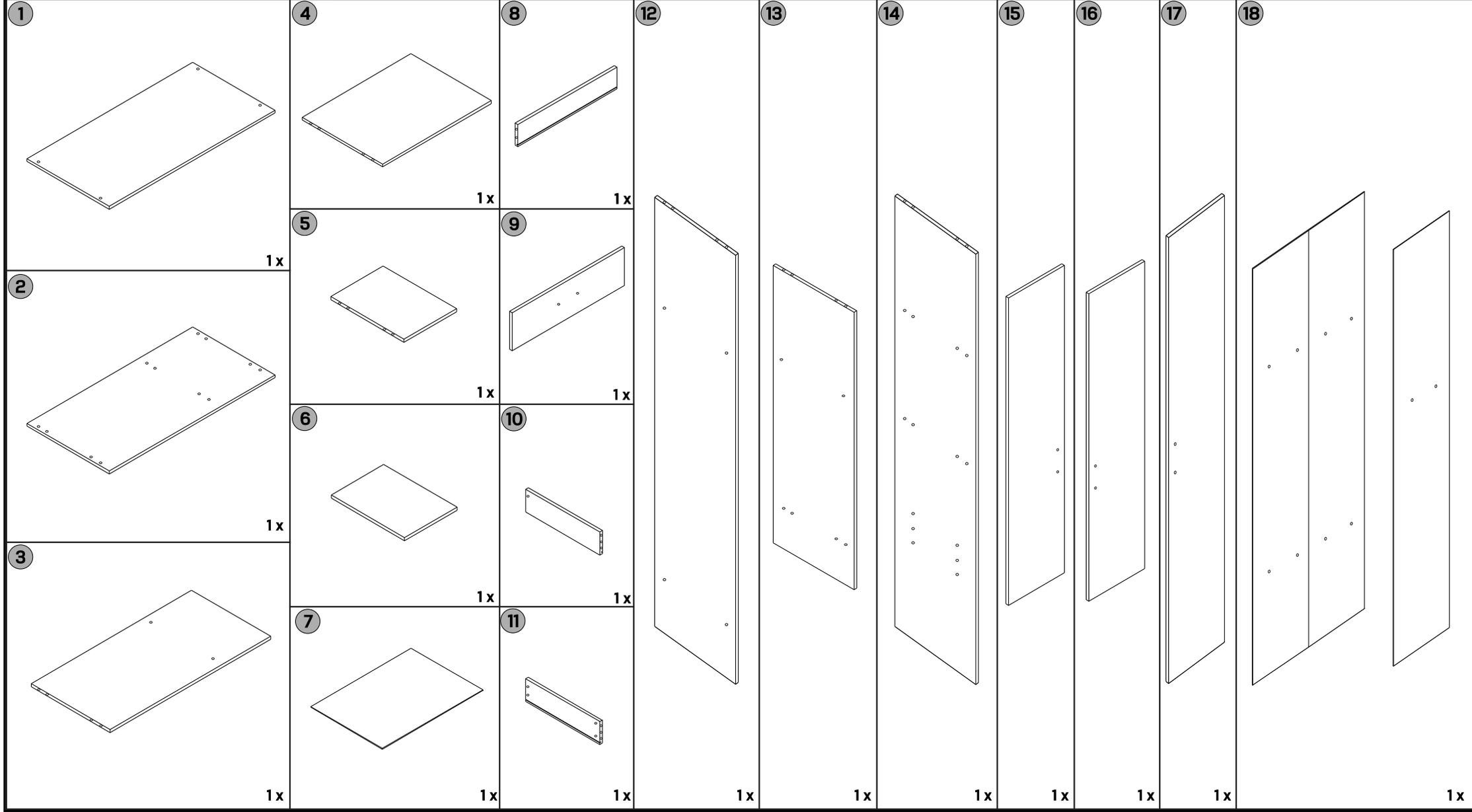

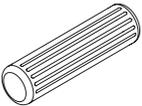
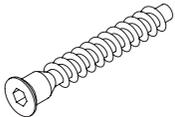
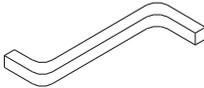
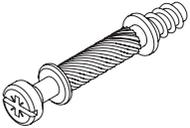
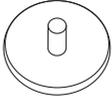
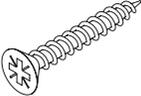
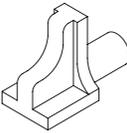
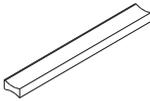
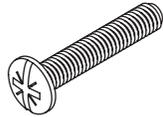
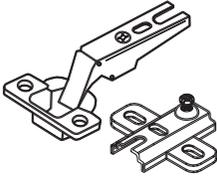
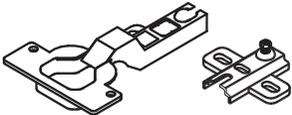
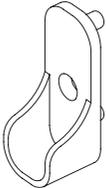
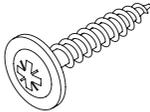
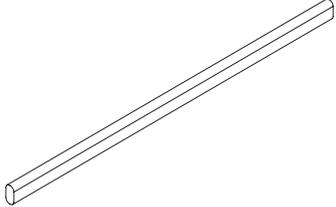
<p><b>A1</b></p>  <p>28 x</p>	<p><b>A2</b></p>  <p>26 x</p>	<p><b>A3</b></p>  <p>1 x</p>	<p><b>M2</b></p>  <p>4 x</p>
<p><b>M1</b></p>  <p>4 x</p>	<p><b>A4</b></p>  <p>18 x</p>	<p><b>V1</b></p> <p>3,5x16 mm</p>  <p>36 x</p>	<p><b>V4</b></p> <p>4x30 mm</p>  <p>10 x</p>
<p><b>C1</b></p>  <p>50 x</p>	<p><b>R1</b></p>  <p>4 x</p>	<p><b>K1</b></p>  <p>4 x</p>	<p><b>V10</b></p>  <p>8 x</p>
<p><b>M4</b></p>  <p>5 x</p>	<p><b>M5</b></p>  <p>2 x</p>	<p><b>G3</b></p>  <p>2 x</p>	<p><b>R5</b></p>  <p>1 x</p>
<p><b>F1</b></p>  <p>5 x</p>	<p><b>V9</b></p>  <p>15 x</p>	<p><b>G1</b></p>  <p>1 x</p>	

0 1 2 3 4 5 cm

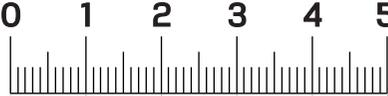

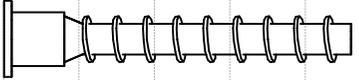
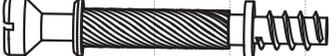
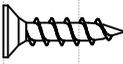
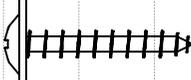
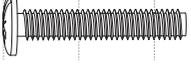
<b>A2</b>			
<b>M1</b>			
<b>A1</b>			
<b>V4</b>			4x30 mm
<b>V1</b>			3,5x16 mm
<b>C1</b>			
<b>V9</b>			
<b>V10</b>			

1

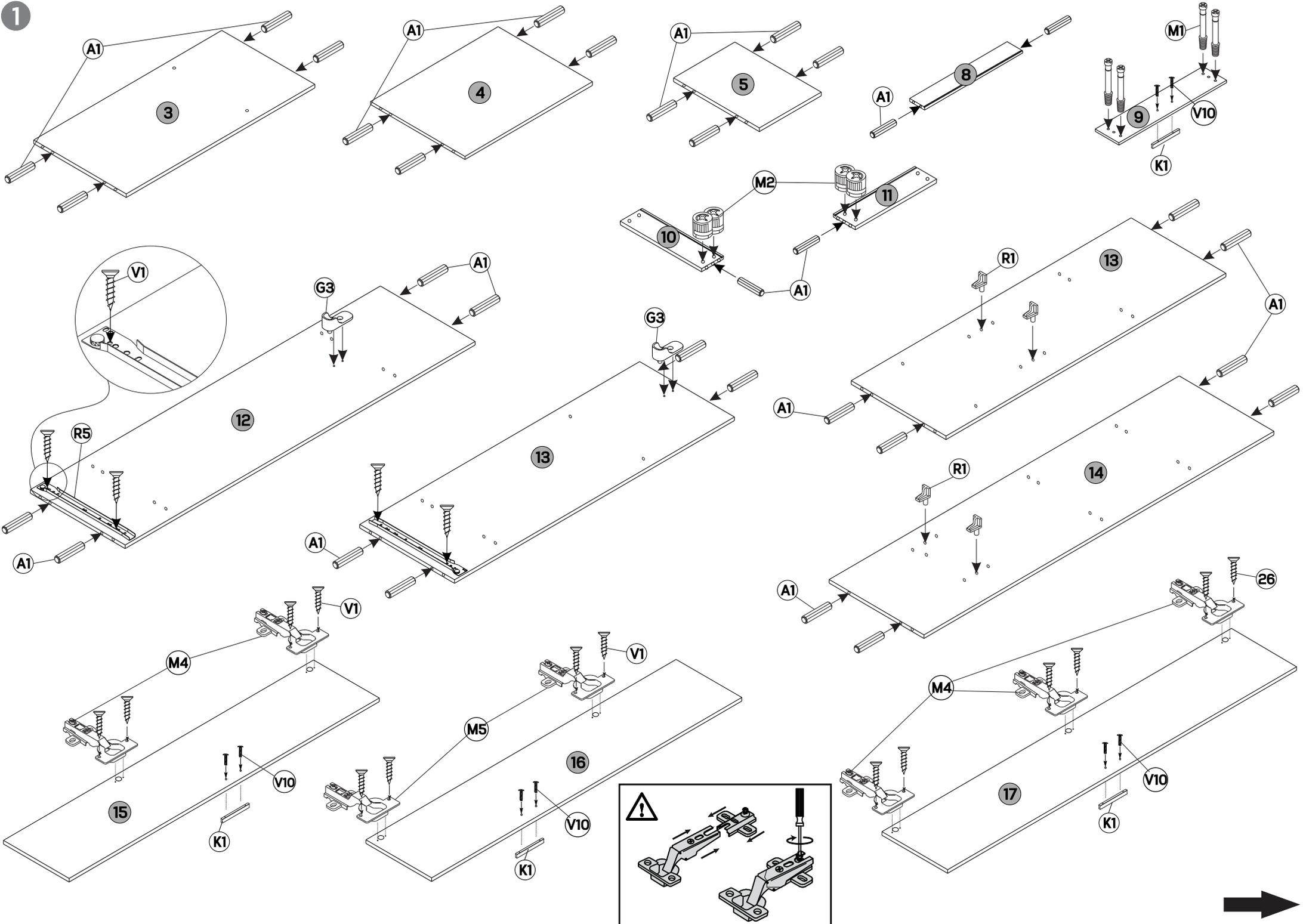

2

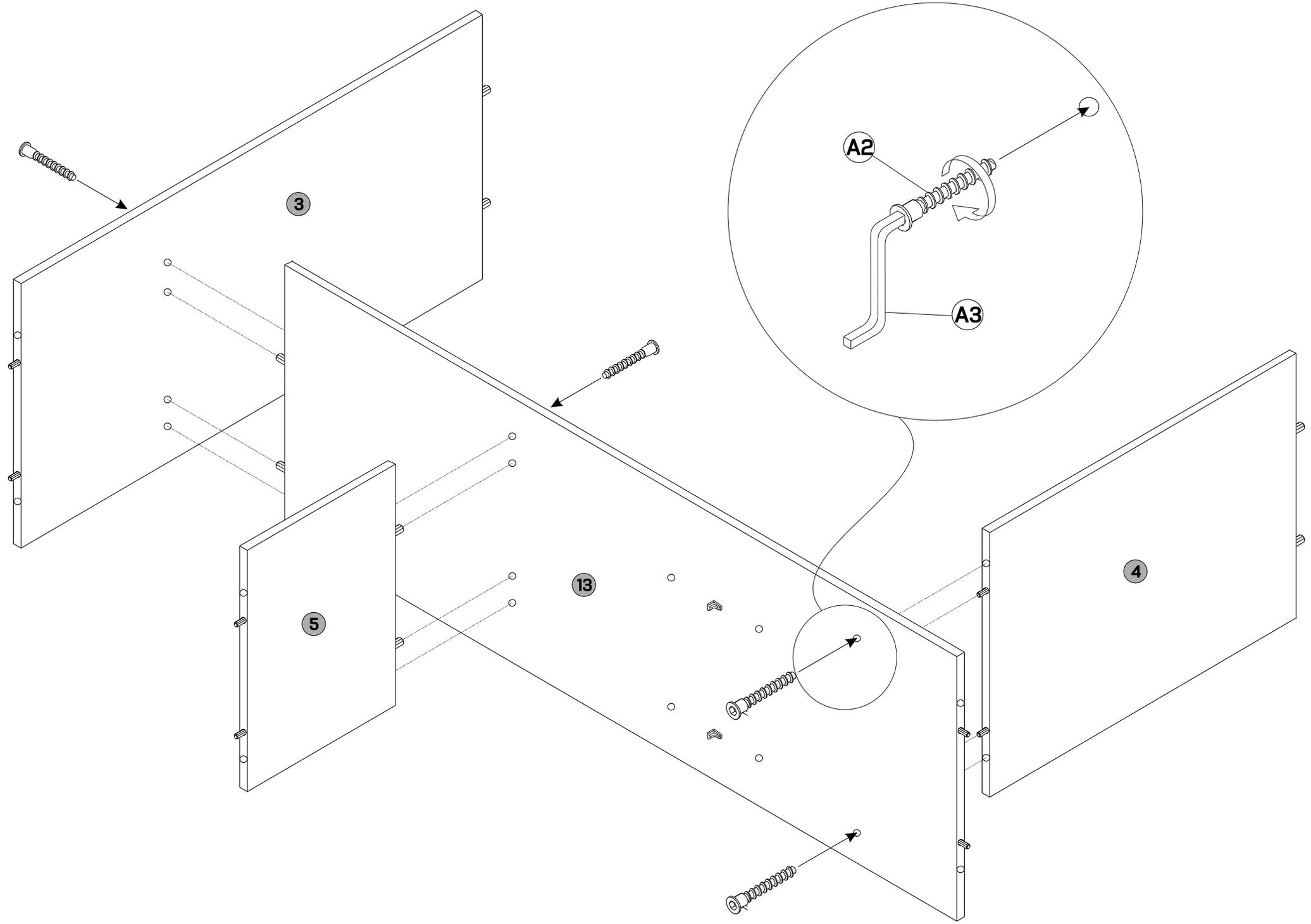

3

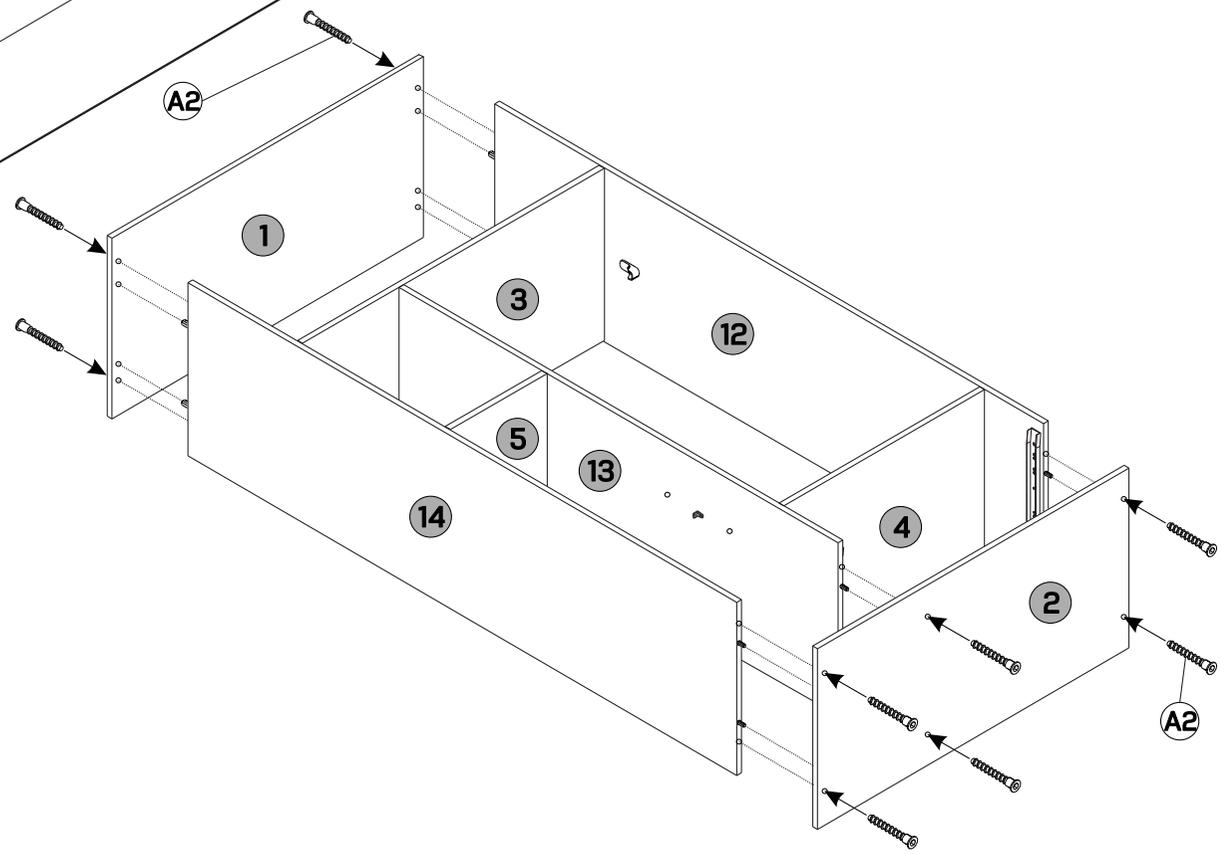
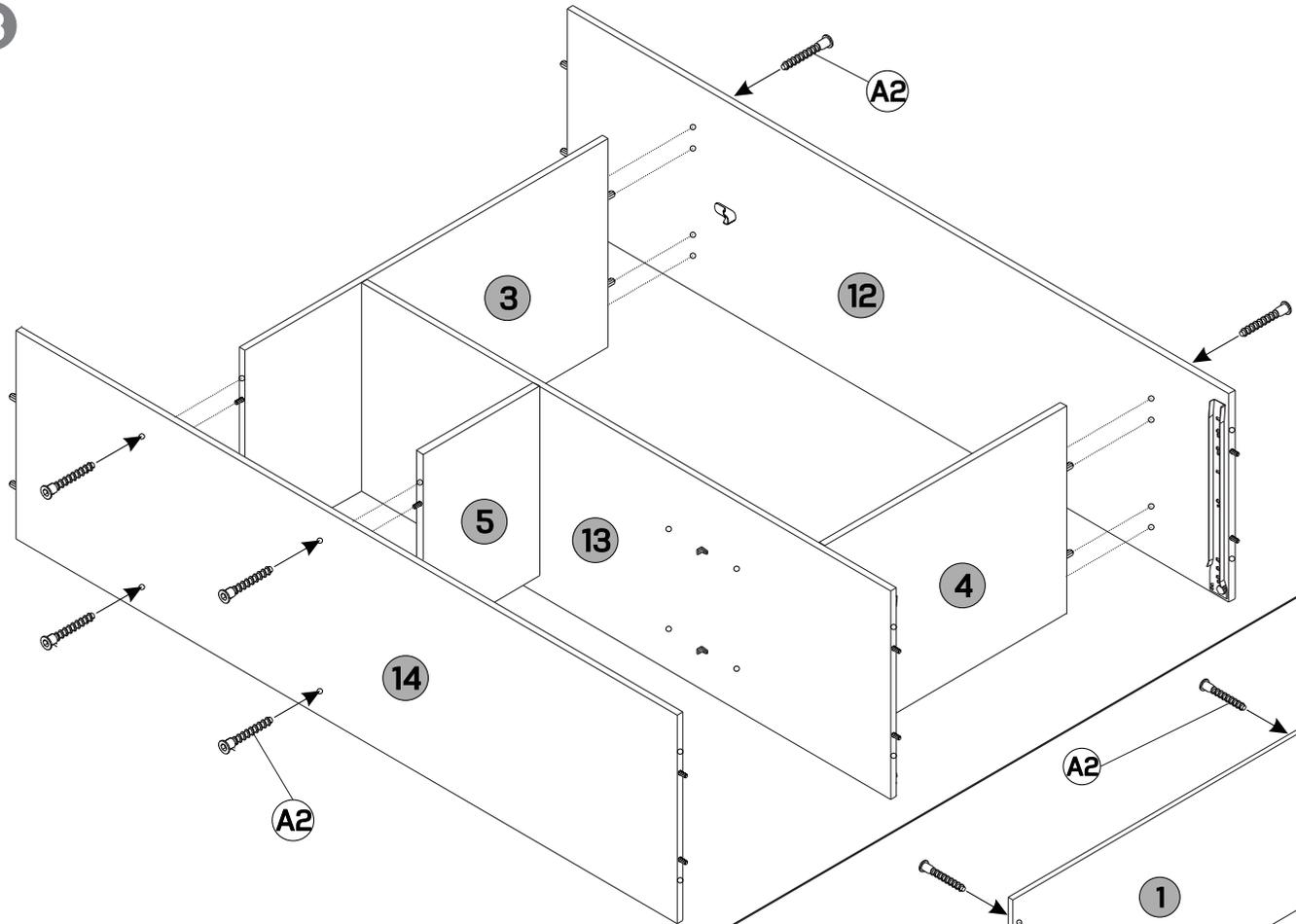

5

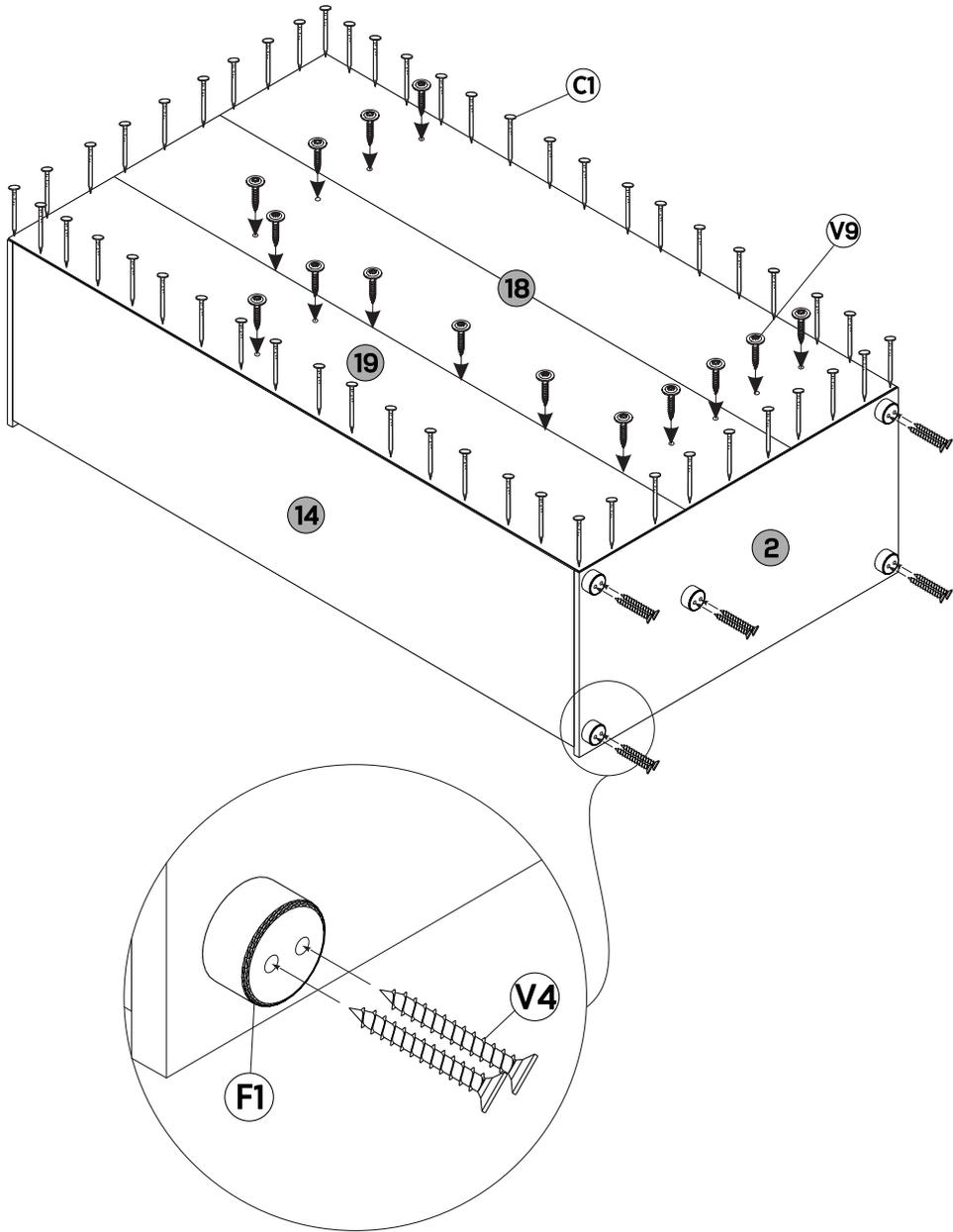

6

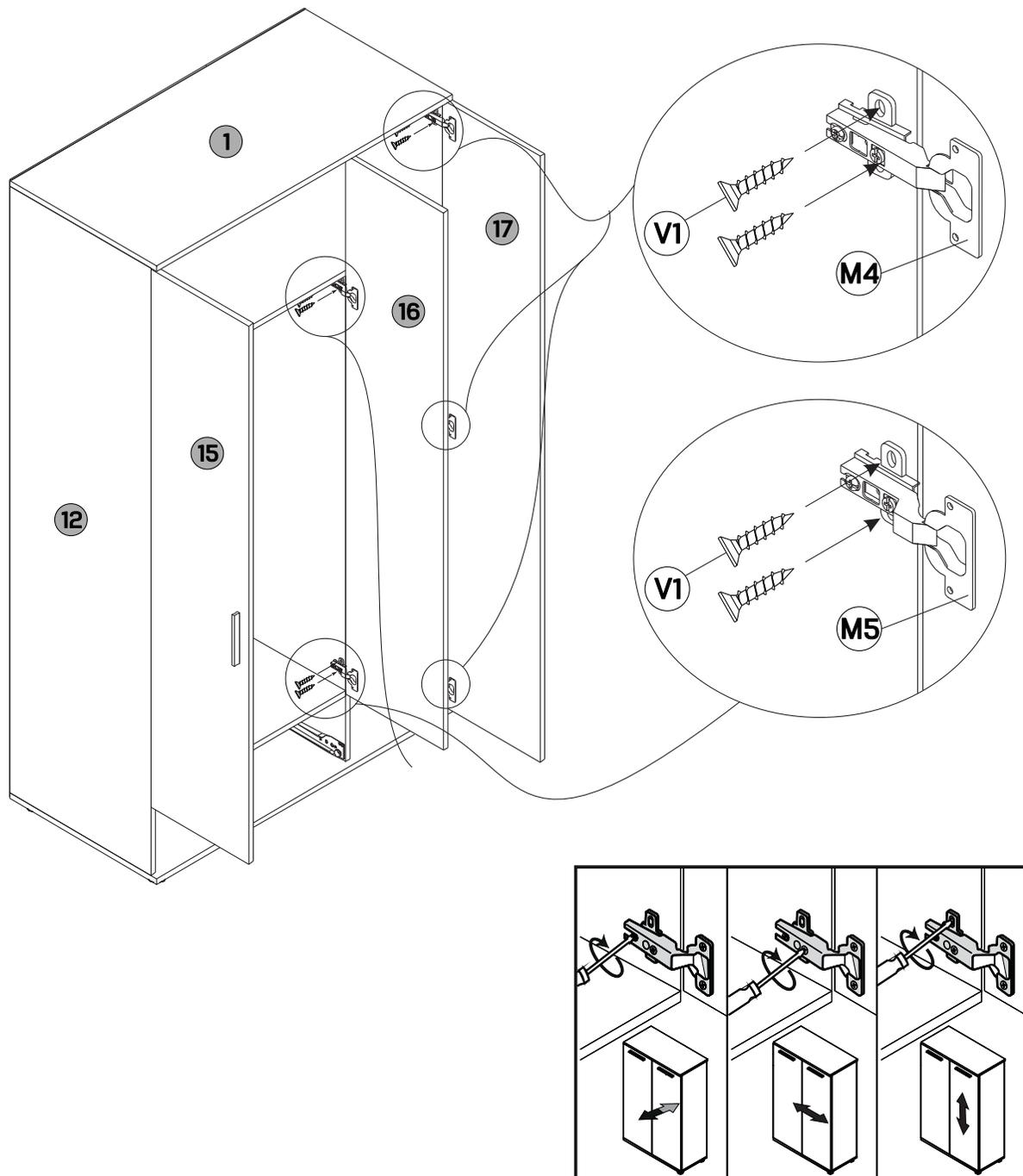

7

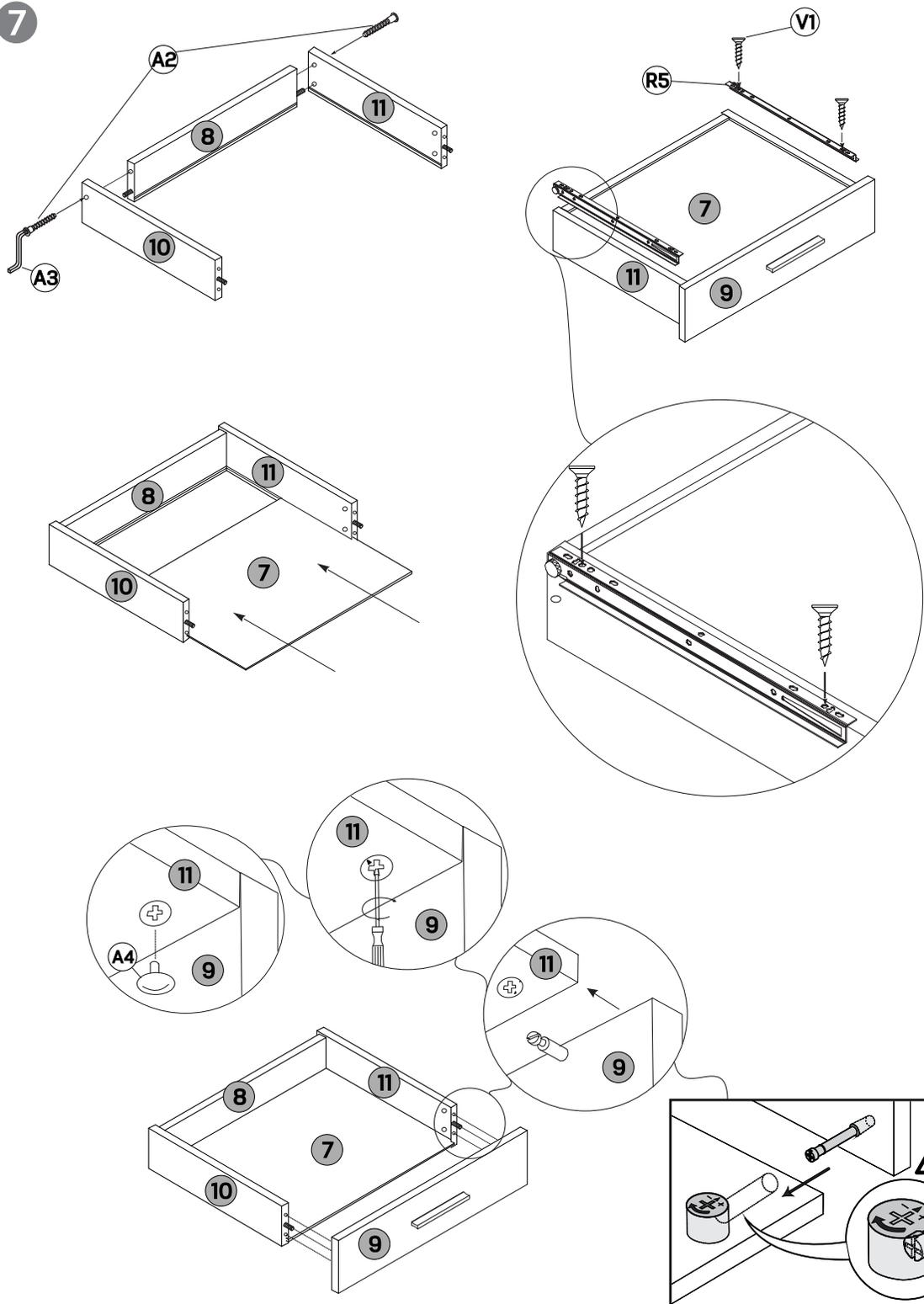

8

