

EN AZ İKİ KİŞİ  
İLE KURUNUZ!

TWO PERSON  
ASSEMBLY  
REQUIRED!



Rev. 00 / 06.12.2018

**TR**  
Garanti şartlarının geçerli olması için kurulum  
semasındaki sıraya uygun olarak montaj  
yapılması gerekmektedir.  
Hatasız ve daha kolay montaj için tüm parçaları  
önce geniş ve düz zemine diziniz.  
Şemada gösterilen parça listesi ile ürün  
kutusundan çıkan parçaları karşılaştırmız.  
Montajı ürün kolisi üzerinde veya sert ve çizici  
olmayan bir zeminde, parça kutusundan çıkan  
«L» şeklindeki alıyan anahtar ile yapınız.  
Montajla ilgili sorularınız ve isteklerimiz için,  
lütfen önce ürünü satın aldıgınız, yetkili  
satıcımıza danışınız.  
Kurulum seması ve garanti belgesini, ödeme  
evraklarınızla saklayınız.

**EN**  
Please read the instruction sheets completely.  
Remove all parts from carton box and ensure all  
parts are included.  
Remove all parts from the carton box and check  
that all parts are included.  
Assemble the product on the carton box or  
carpet to prevent scratching or damage.  
Make assembly with the «L» shaped allen key  
that you will find in the tool bag.

**GR**  
Παρακαλούμε διαβάστε προσεκτικά τα φύλλα  
οδηγίων.  
Αφαιρέστε όλα τα κομμάτια από το κουτί και  
βεβαιωθείτε ότι όλα συμπεριλαμβάνονται.  
Αφαιρέστε όλα τα κομμάτια από το κουτί και  
ελέγξτε ότι όλα συμπεριλαμβάνονται.  
Συναρμολογήστε το προϊόν πάνω στο κουτί ή σε  
χαλί, για να αποφευχθεί τυχόν γρατζουνιές ή φθορές  
του προϊόντος.  
Η συναρμολόγηση γίνεται με το «L» shaped allen που θα  
βρείτε μέσα στο σακουλάκι με τα εργαλεία και τις  
βίδες.

**RO**  
Vă rugăm să citiți instrucțiunile, în totalitate.  
Scoateți toate piesele din cutia de carton și  
asigurați-vă că toate piesele sunt incluse.  
Scoateți toate piesele din cutia de carton și  
controlați dacă toate piesele sunt incluse.  
Asamblați produsul pe cutia de carton sau pe  
un covor, pentru a preveni scrijelirea sau  
deteriorarea.  
Realizați asamblarea cu cheia imbus în formă  
de L pe care o găsiți în trusa de scule.

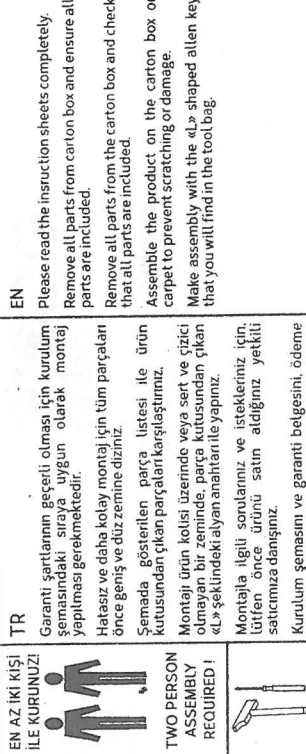
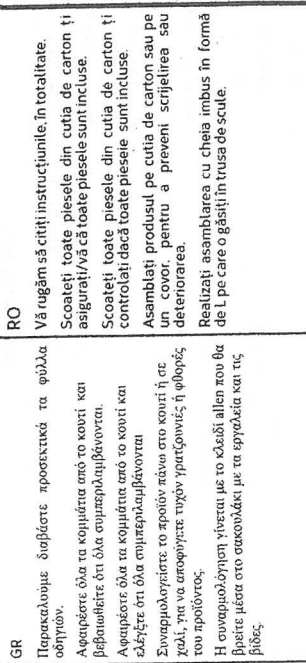
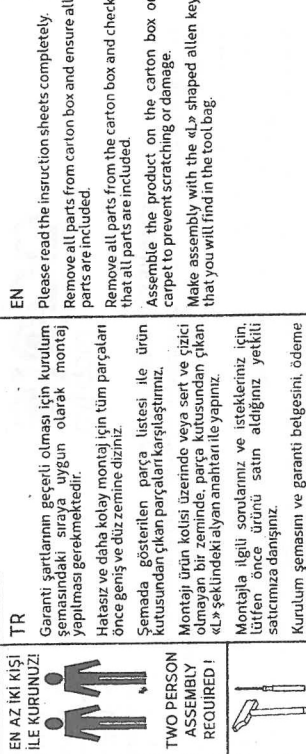
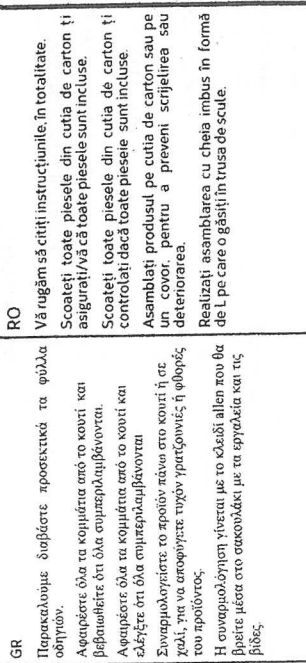
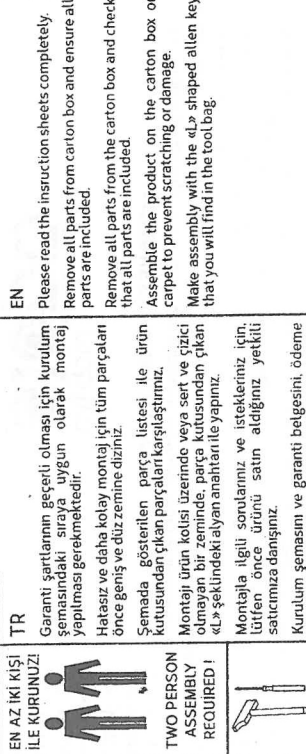
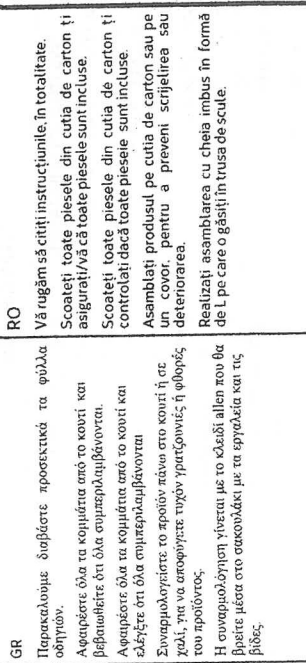
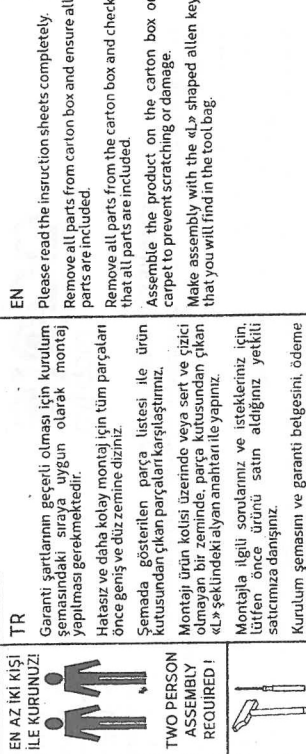
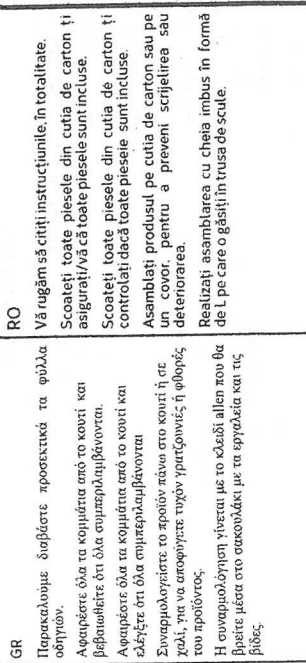
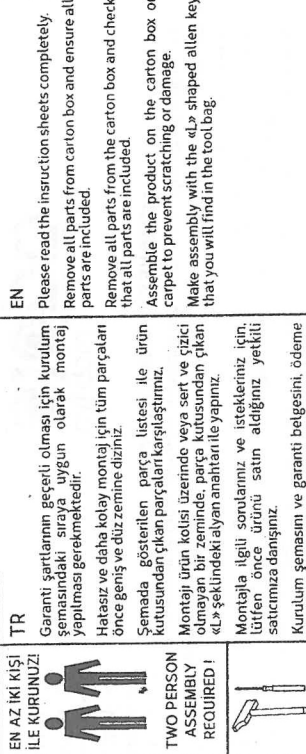
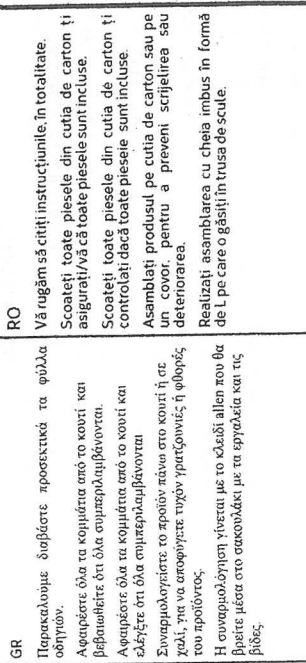
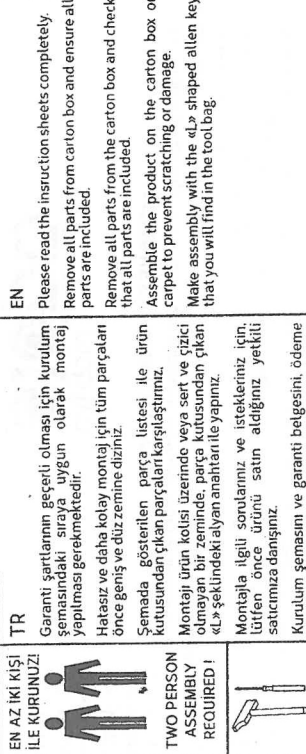
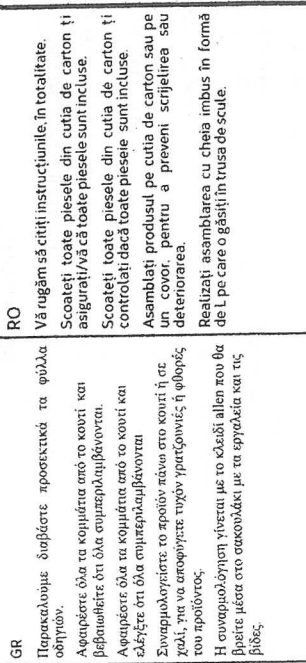
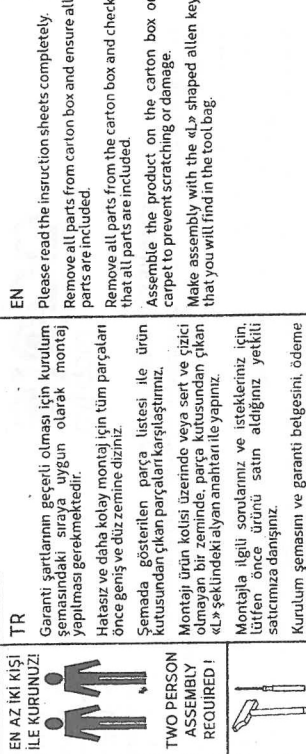
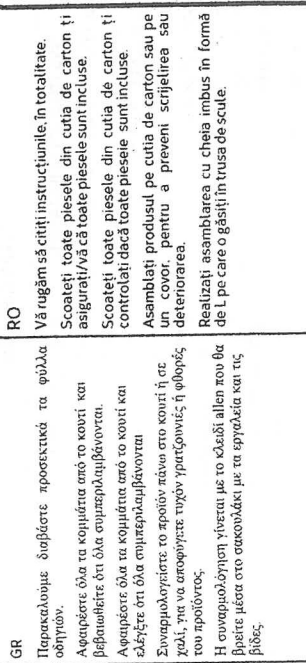
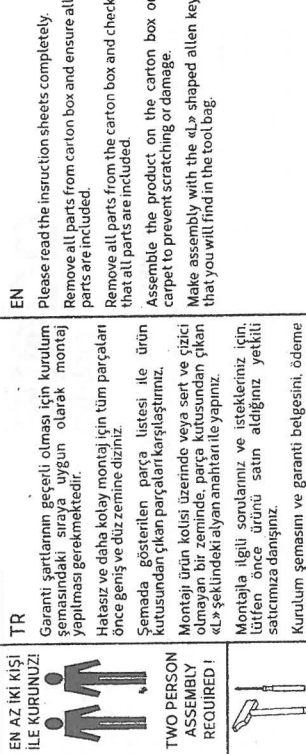
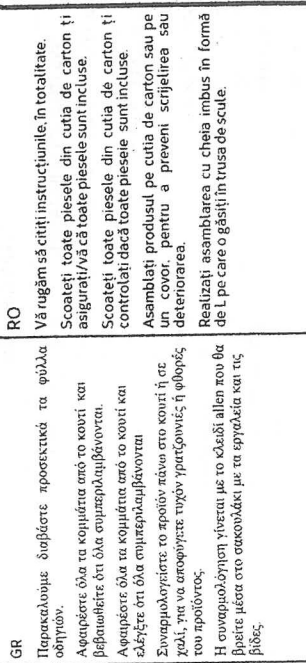
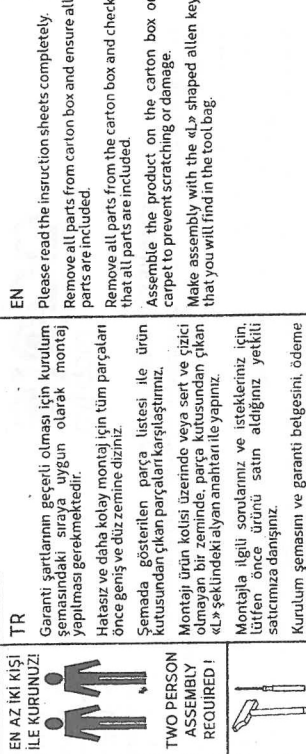
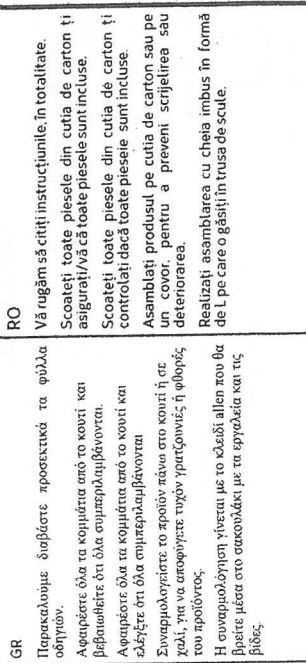
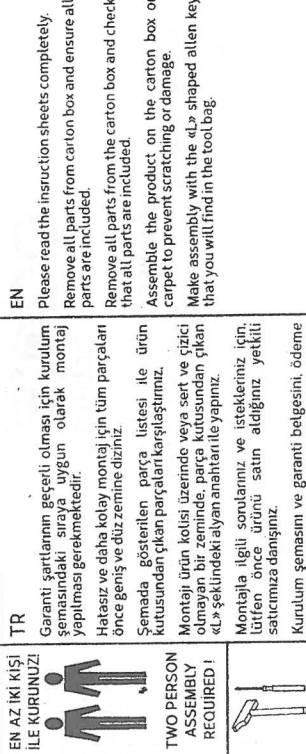
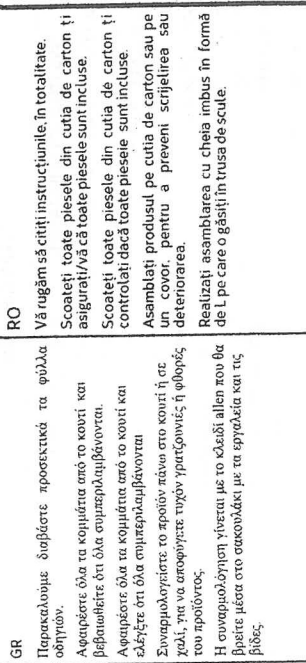
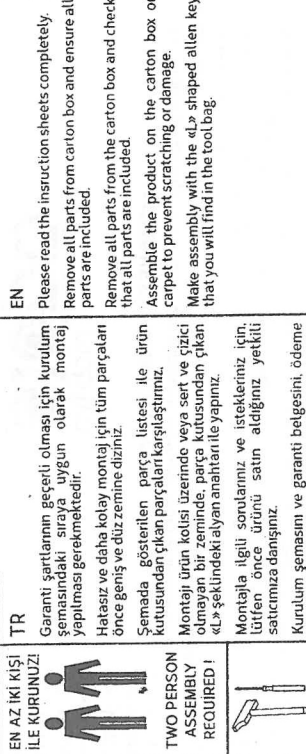
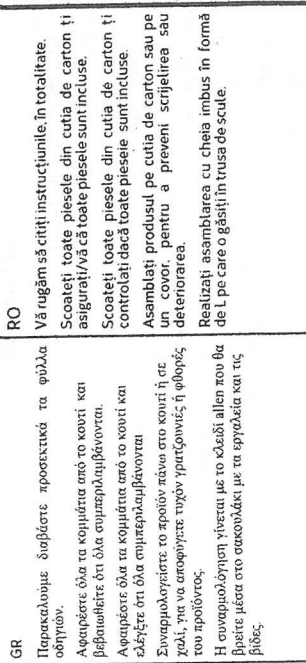
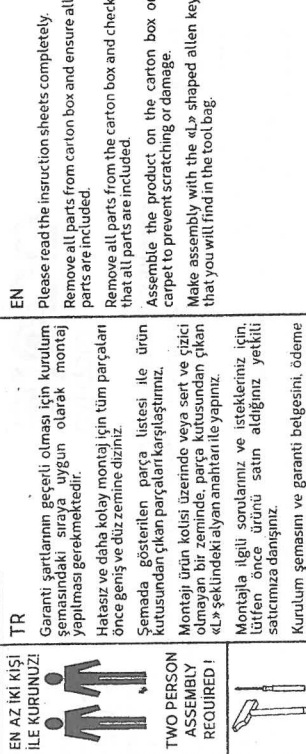
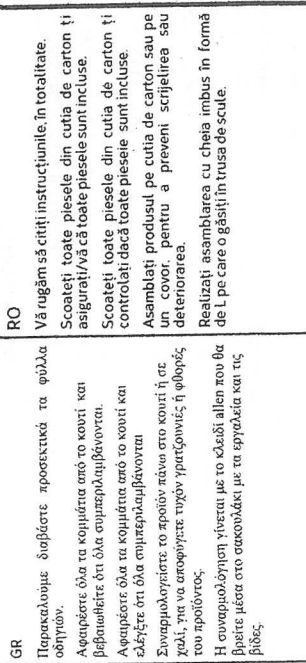
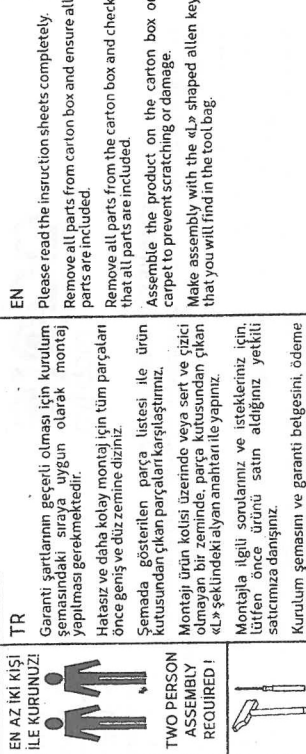
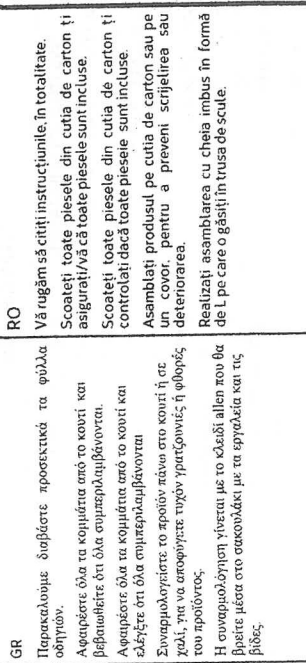
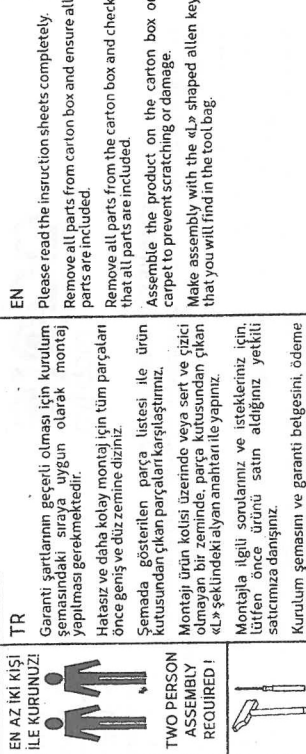
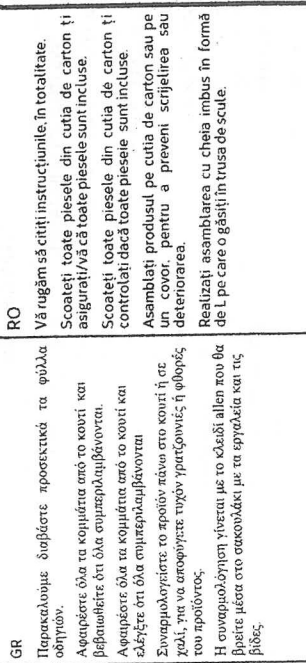
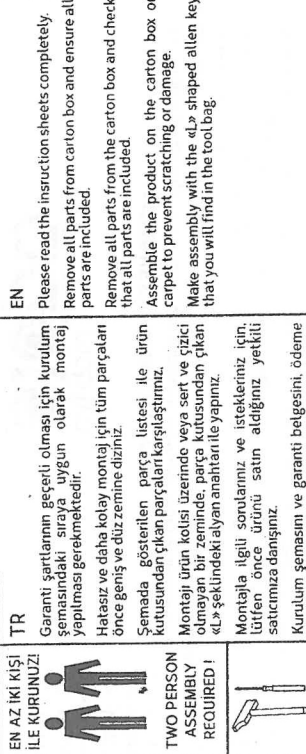
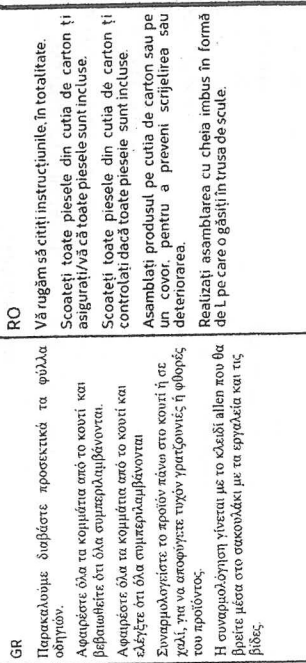
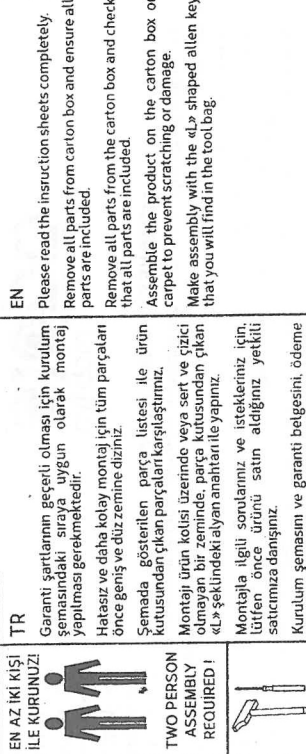
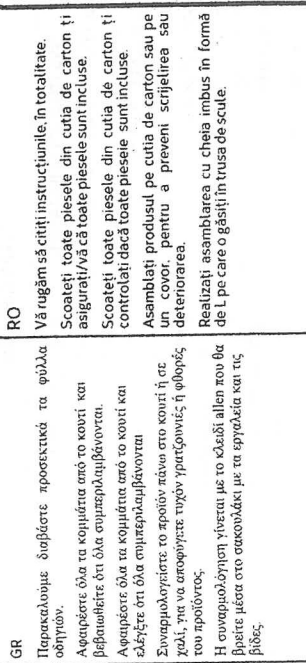
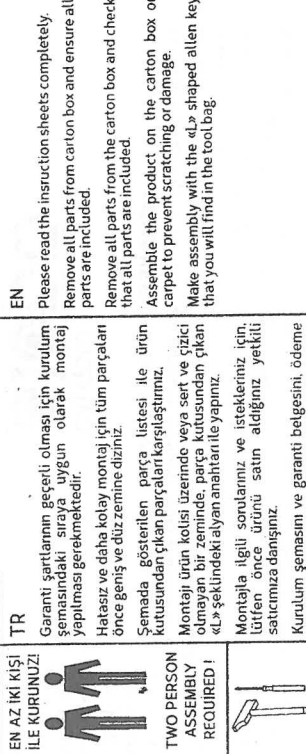
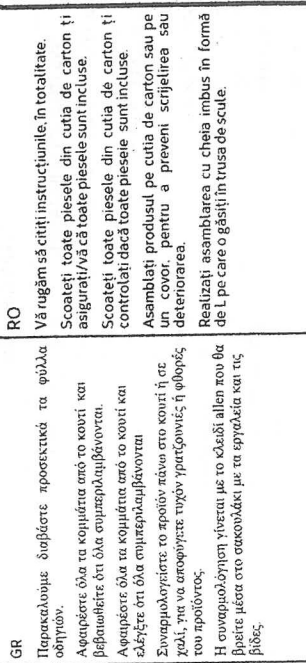
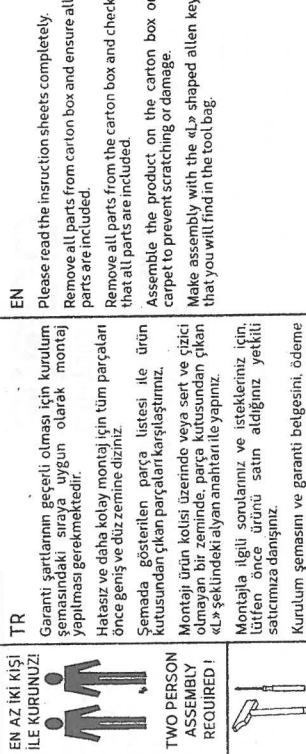
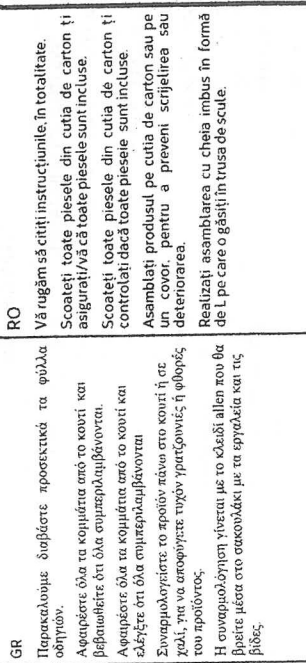
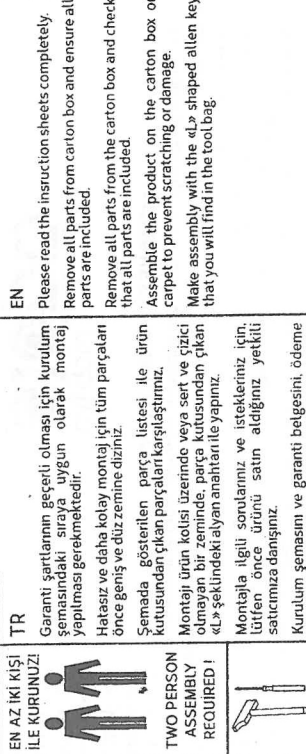
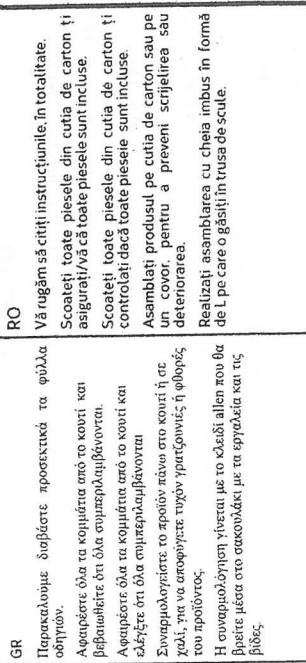
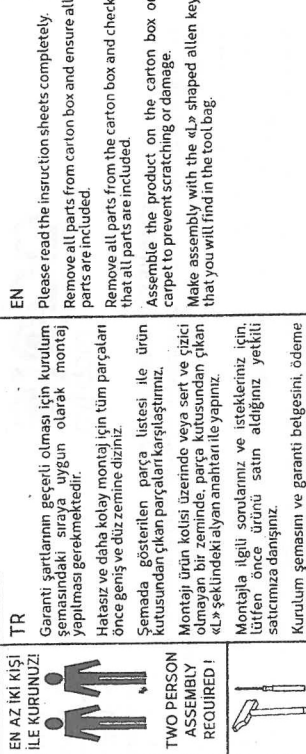
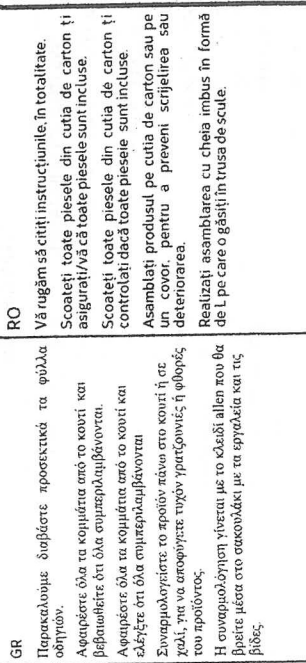
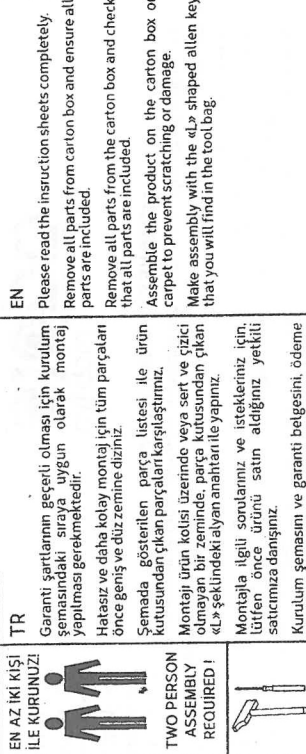
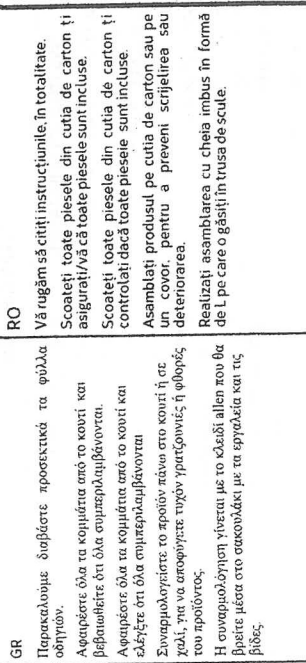
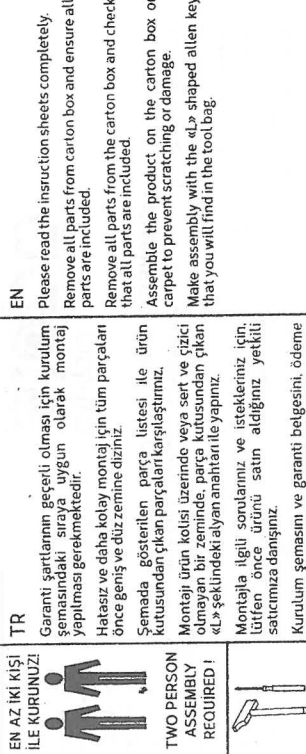
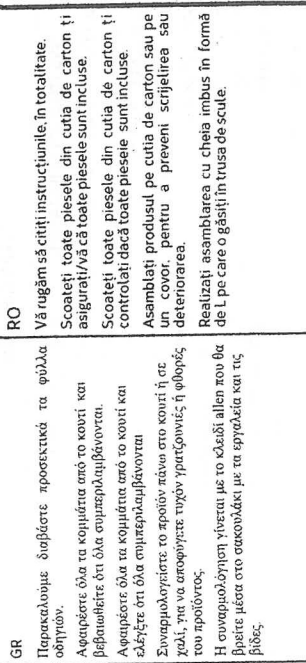
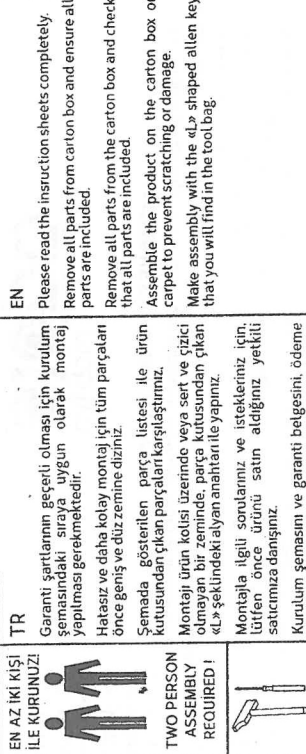
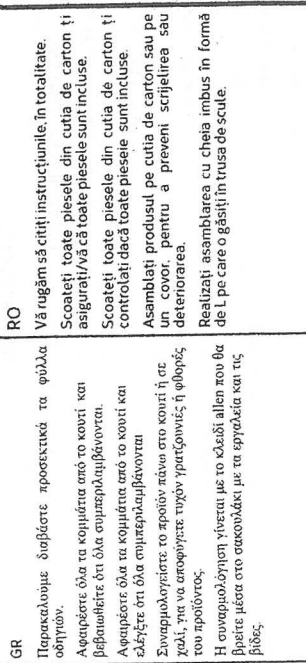
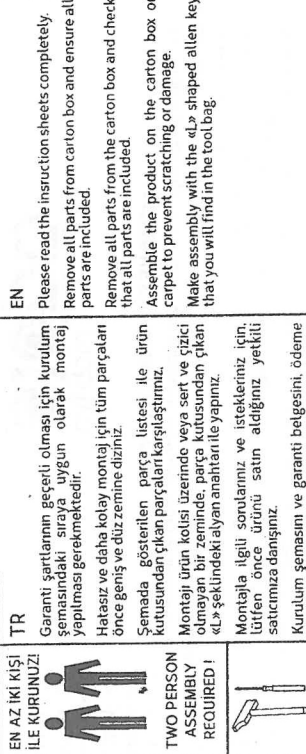
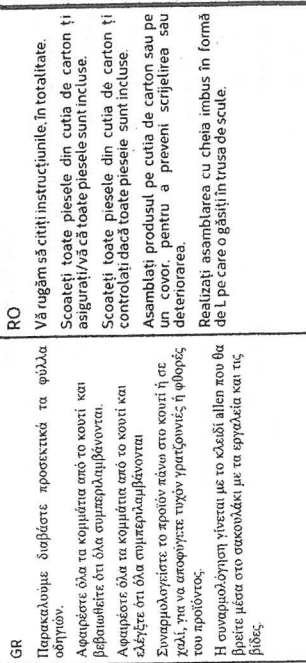
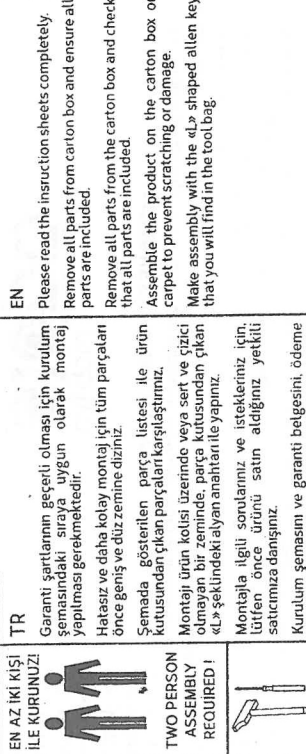
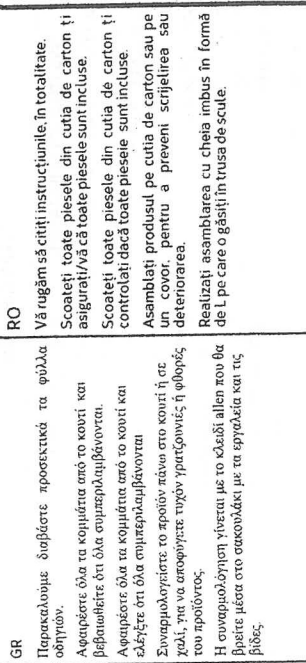
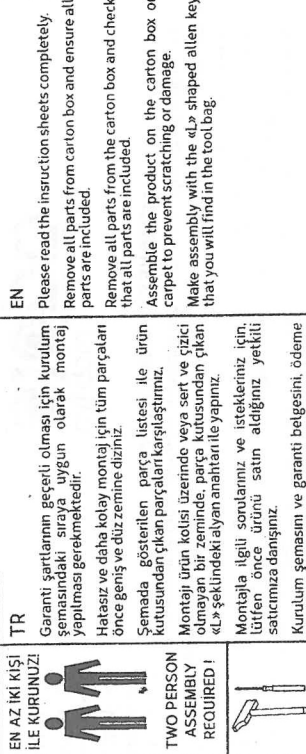
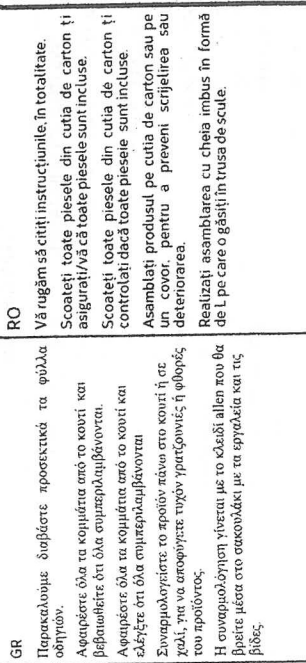
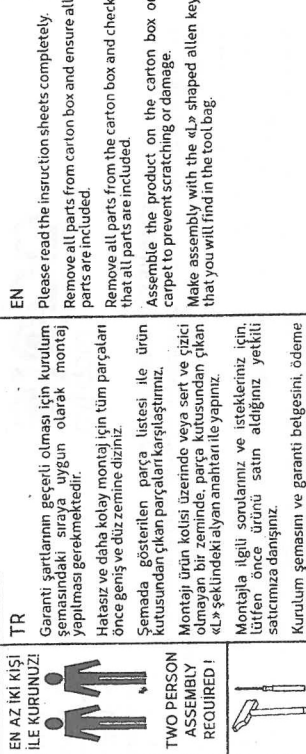
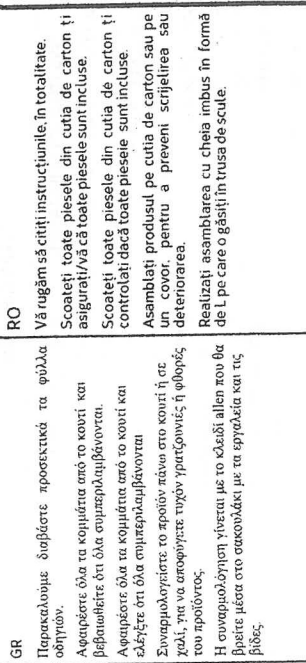
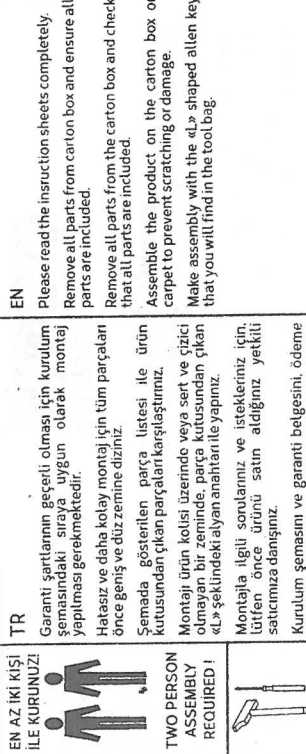
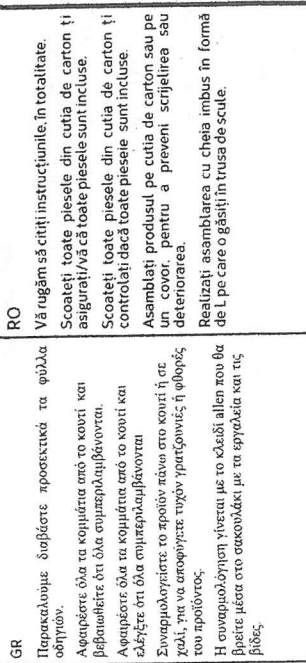
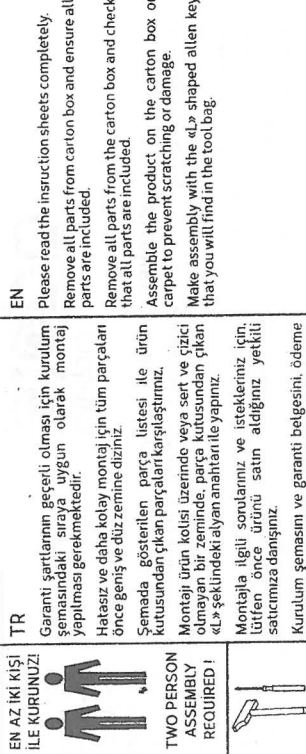
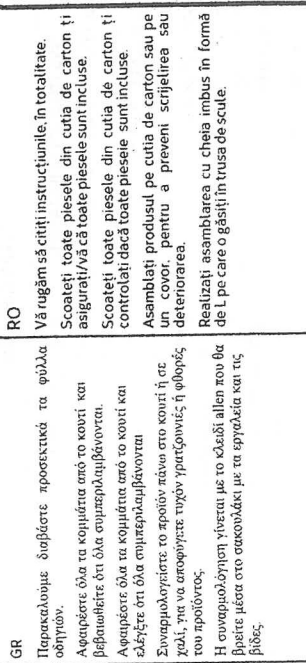
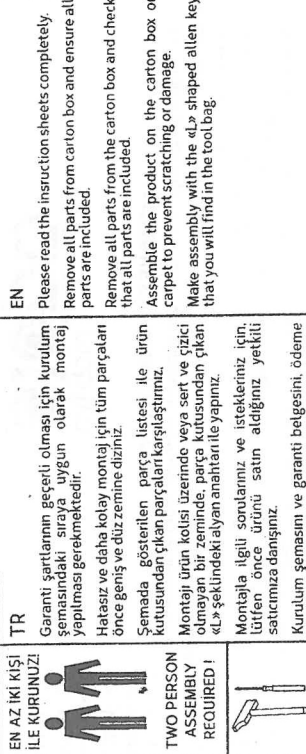
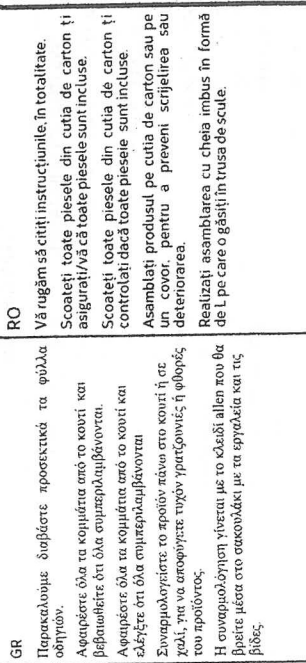
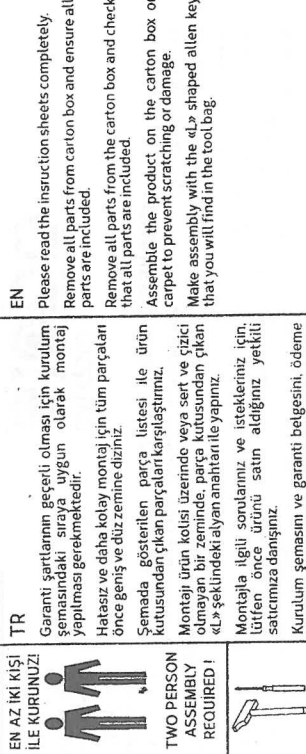
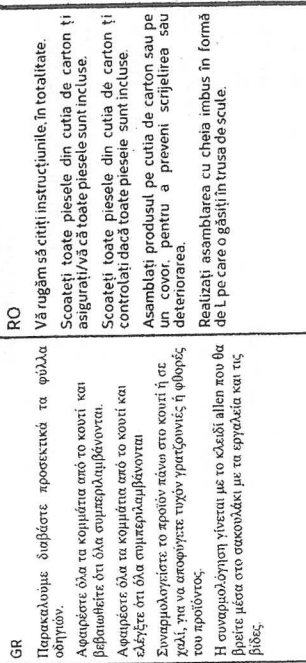
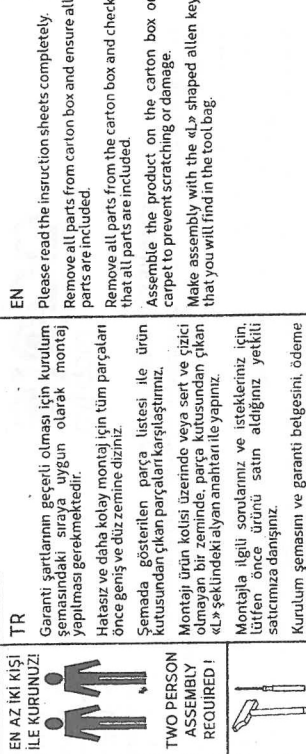
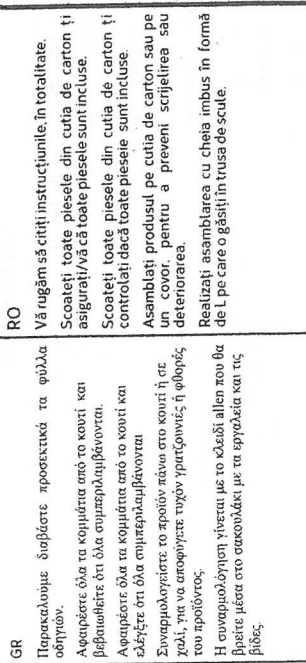
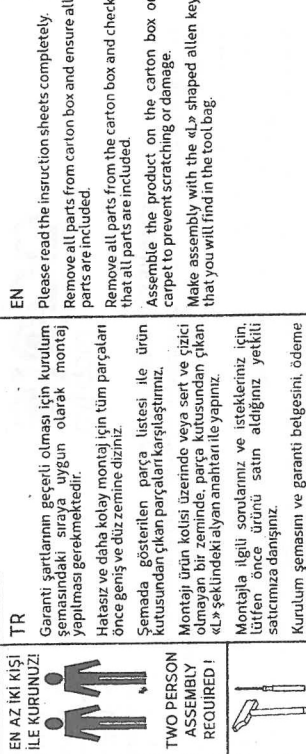
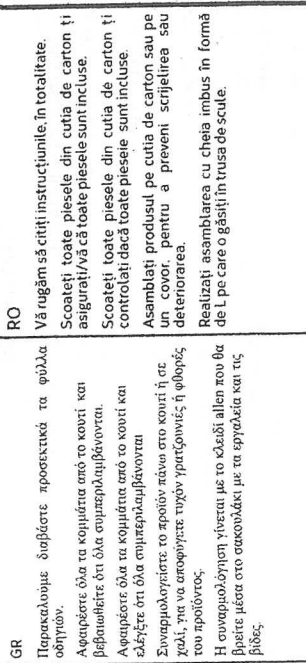
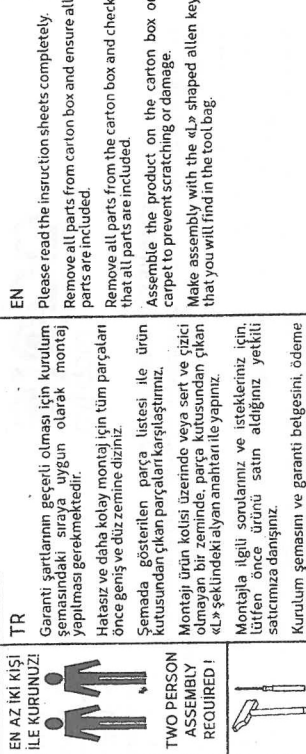
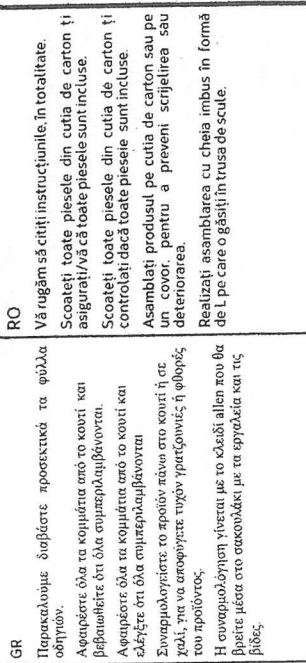
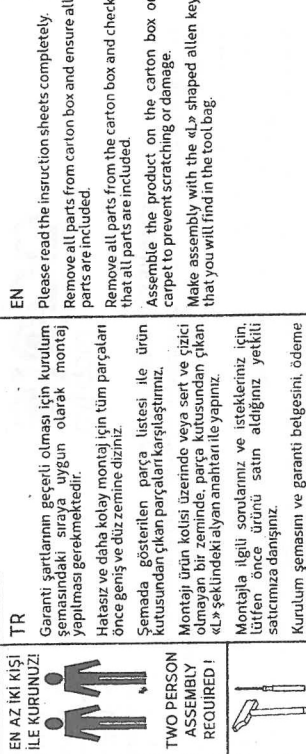
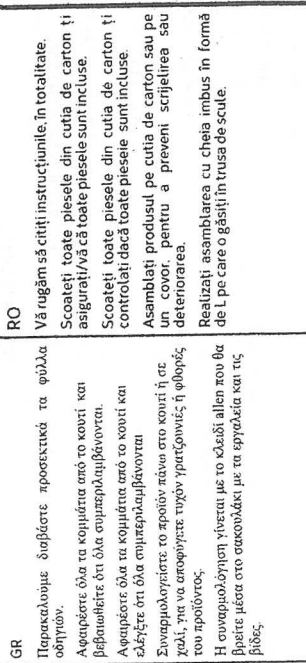
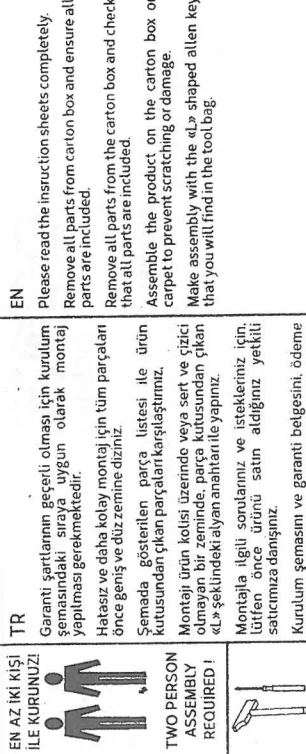
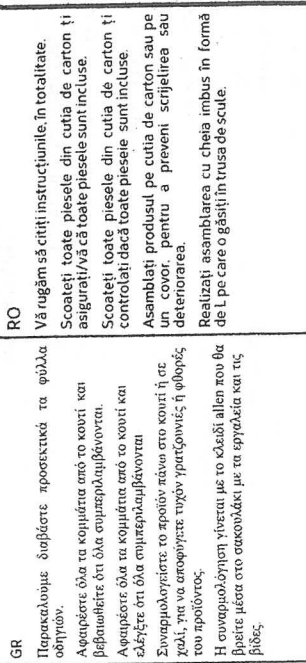
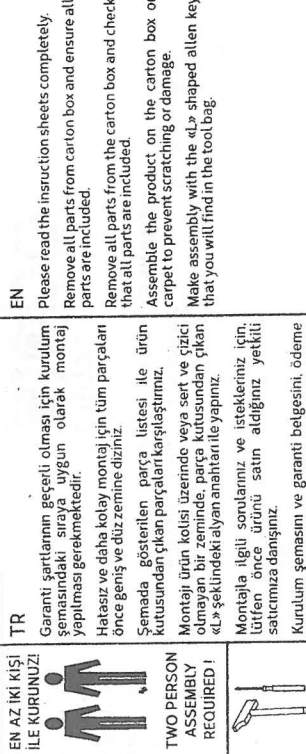
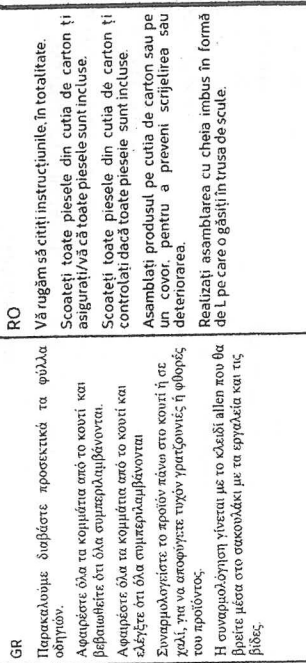
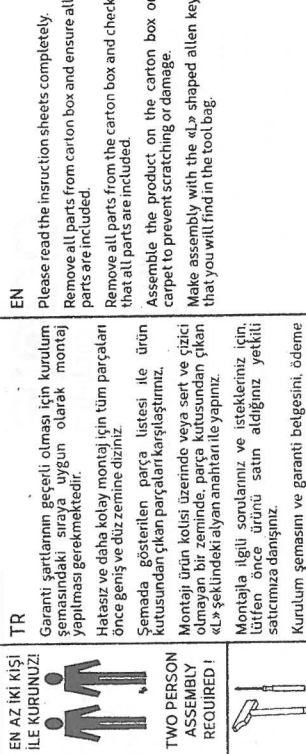
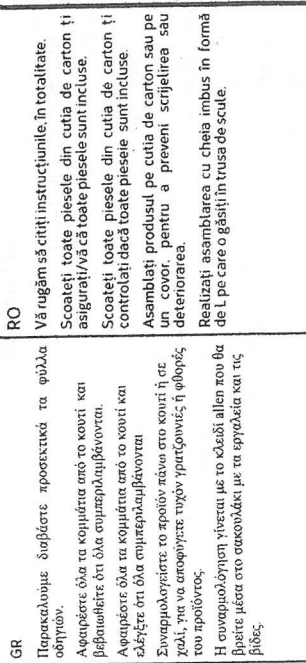
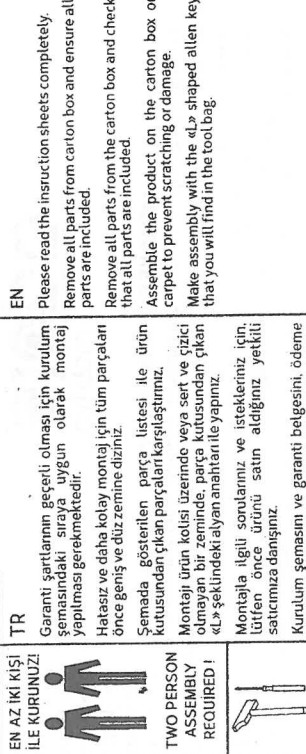
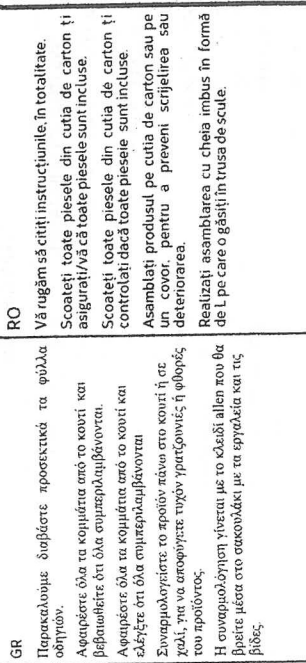
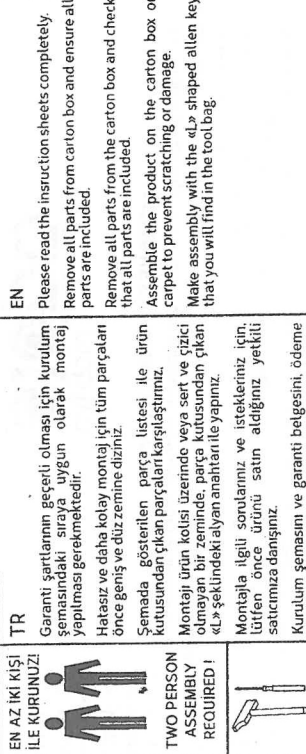
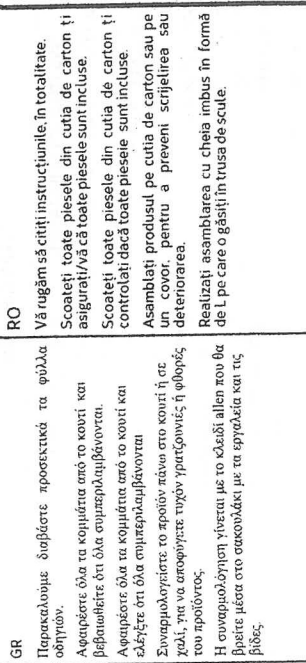
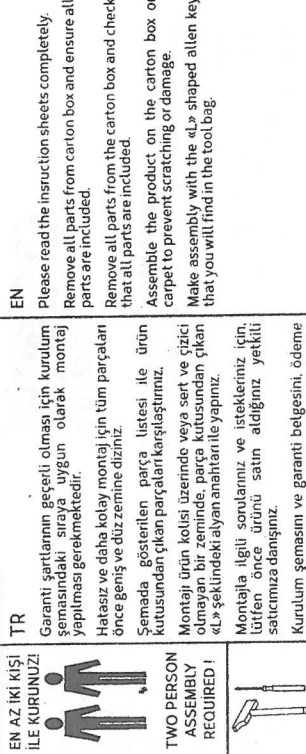
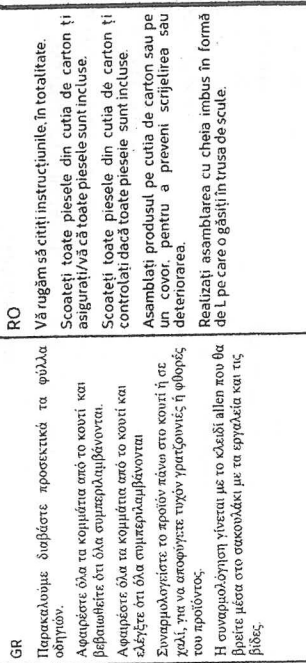
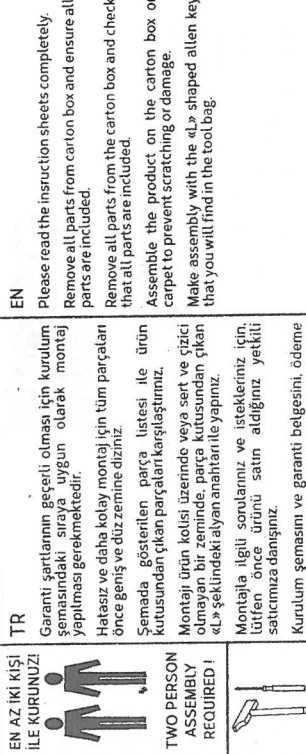
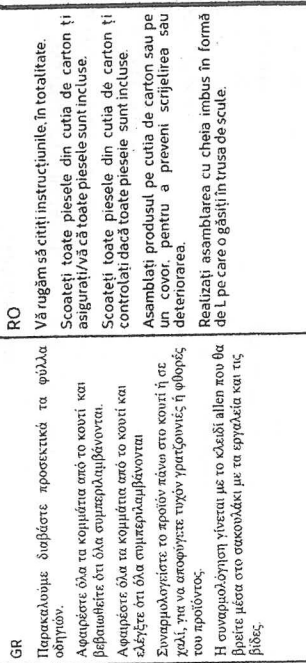
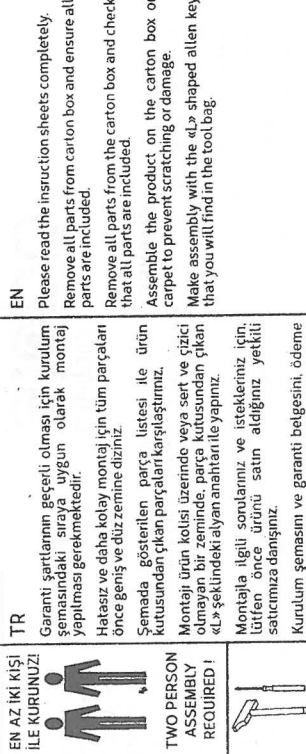
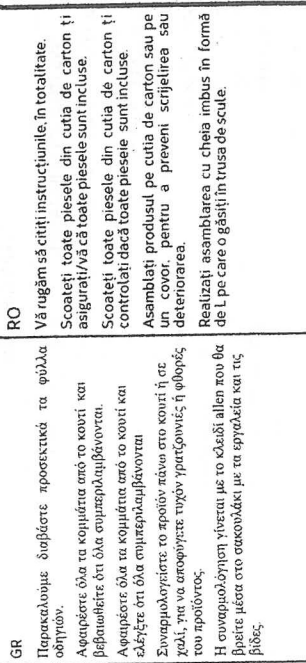
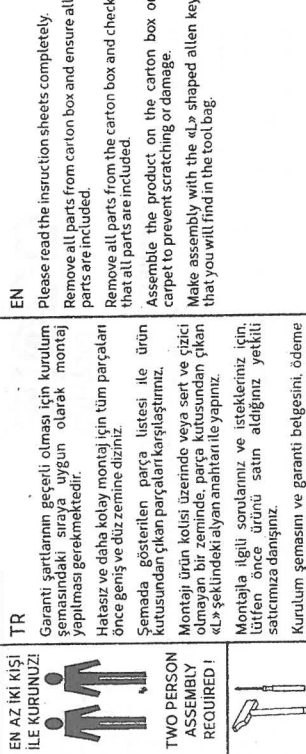
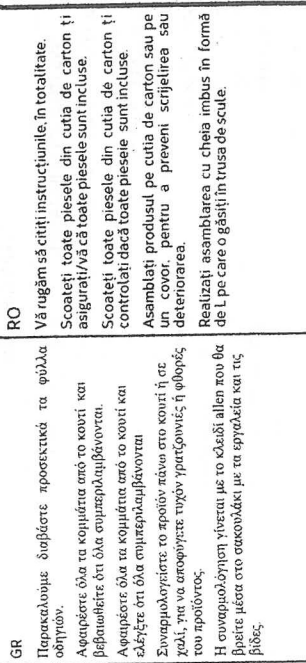
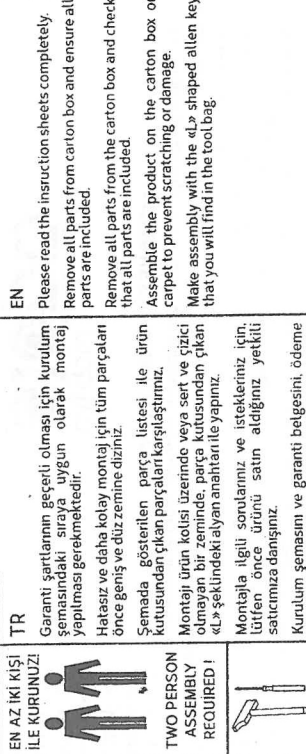
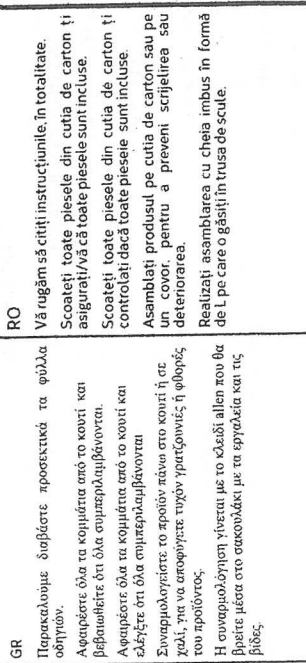
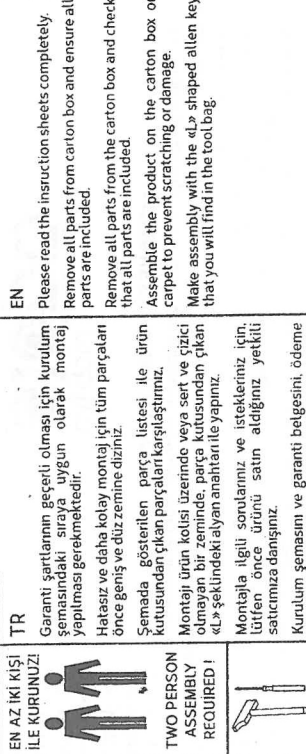
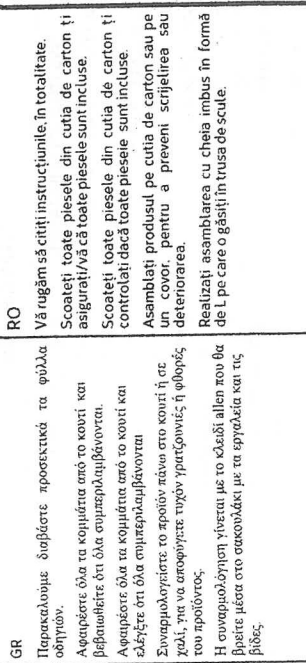
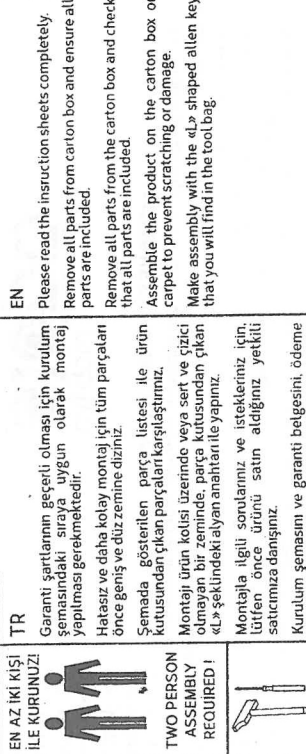
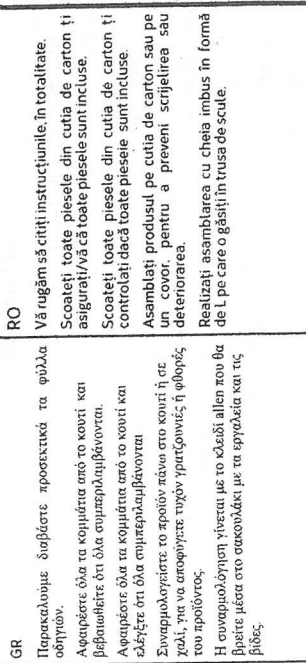
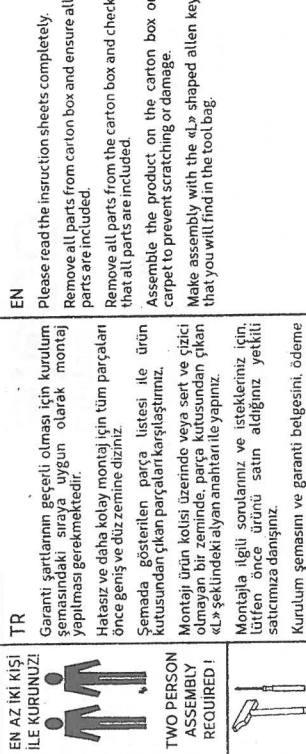
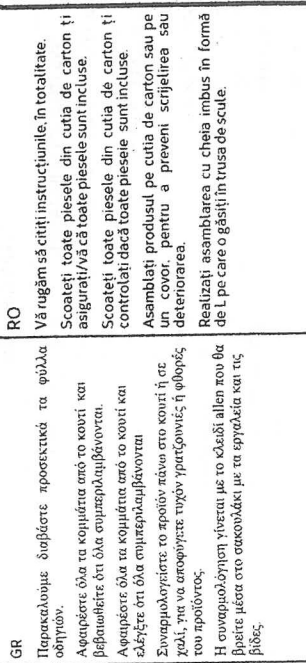
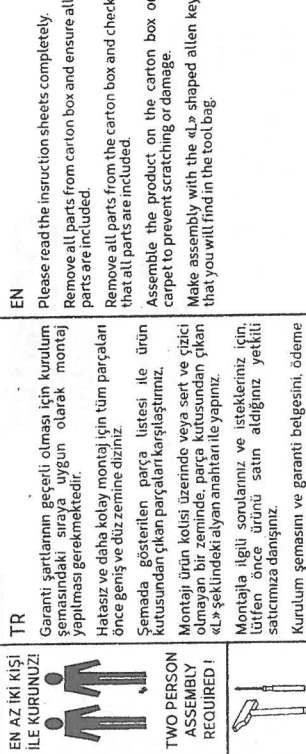
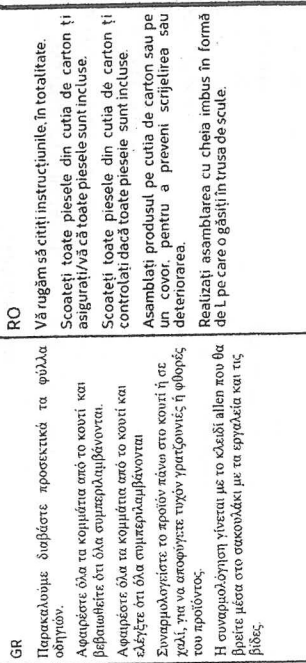
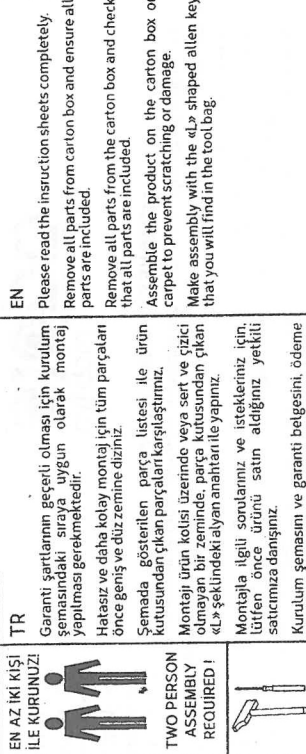
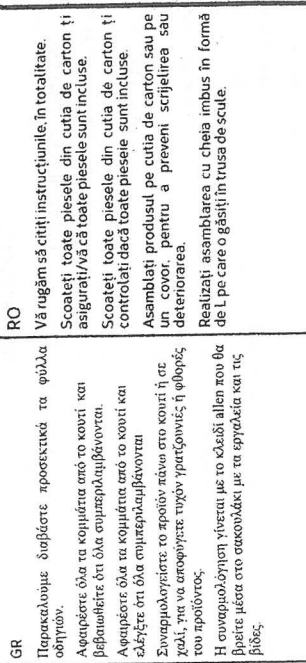
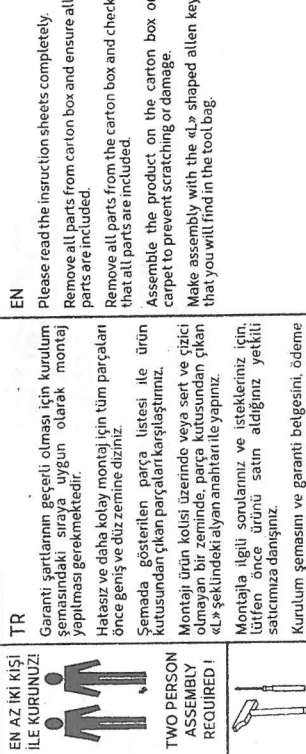
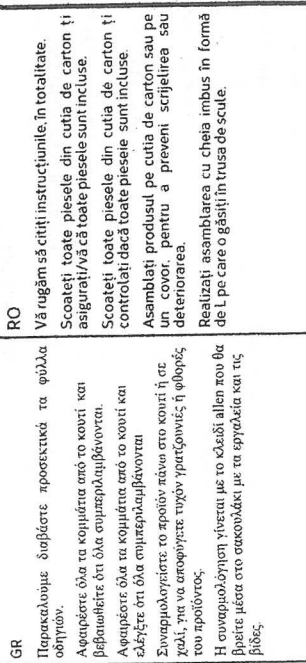
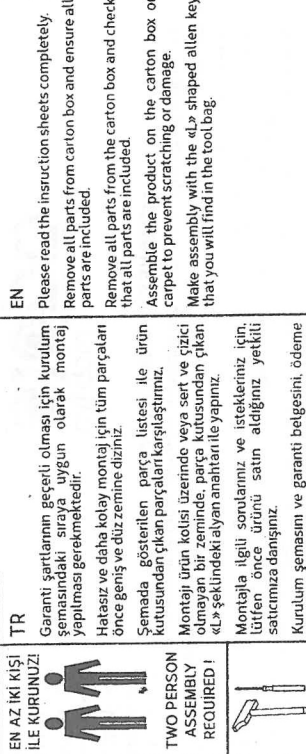
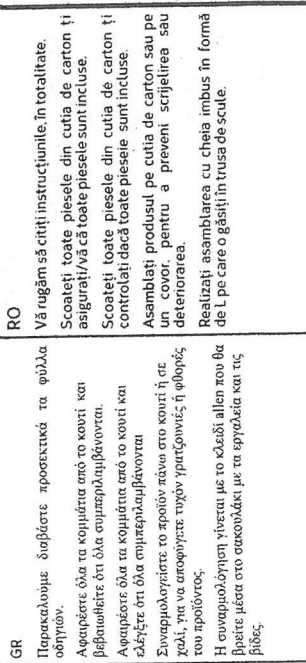
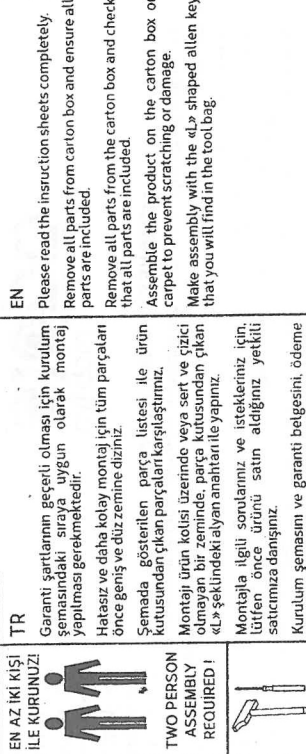
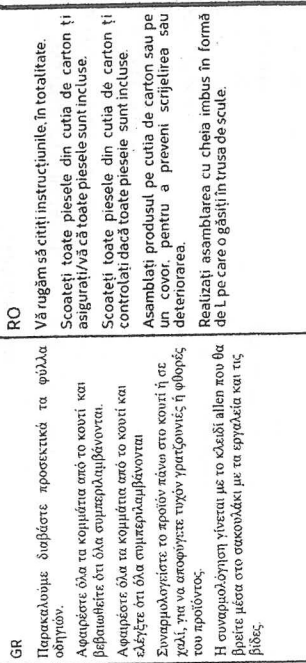
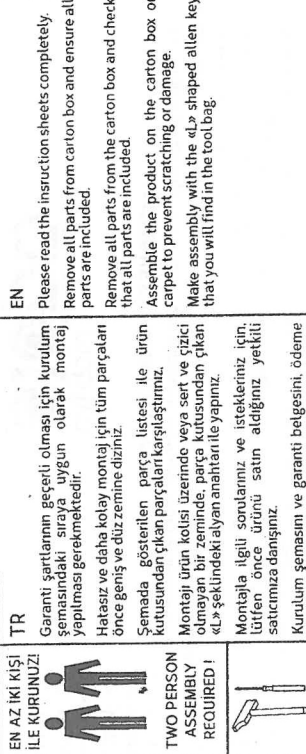
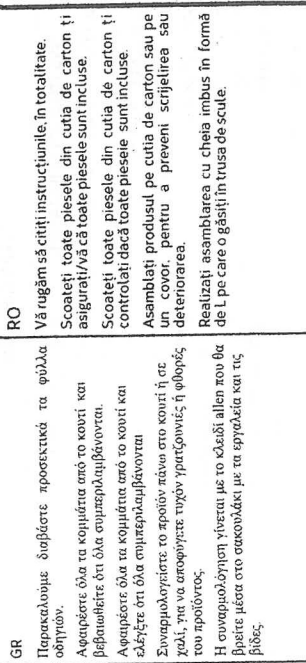
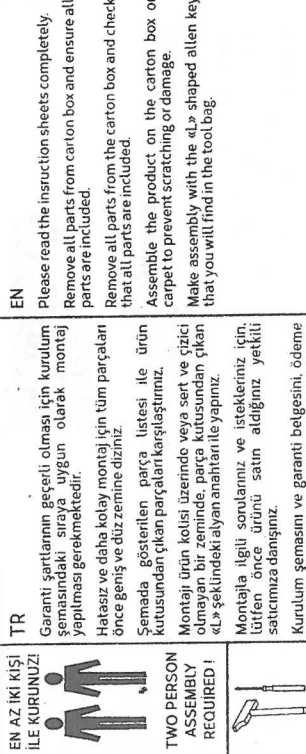
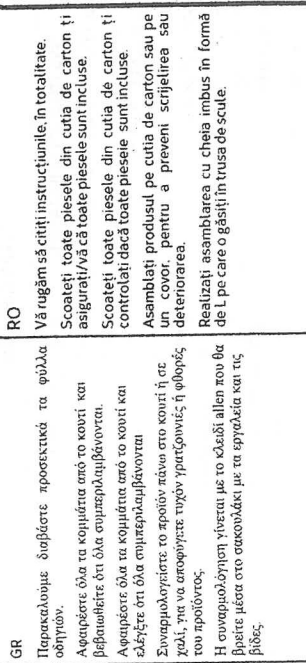
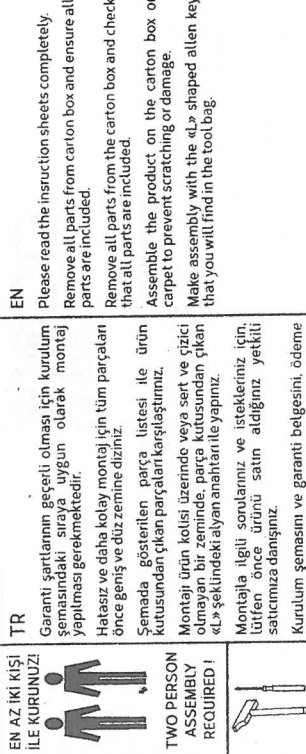
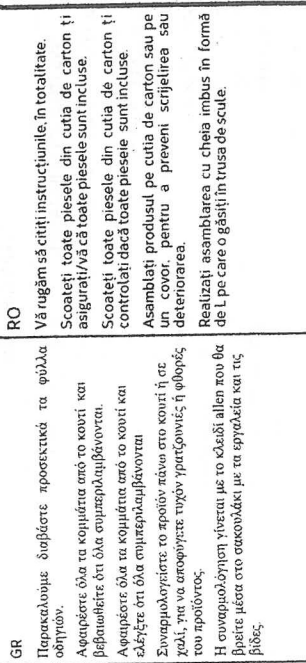
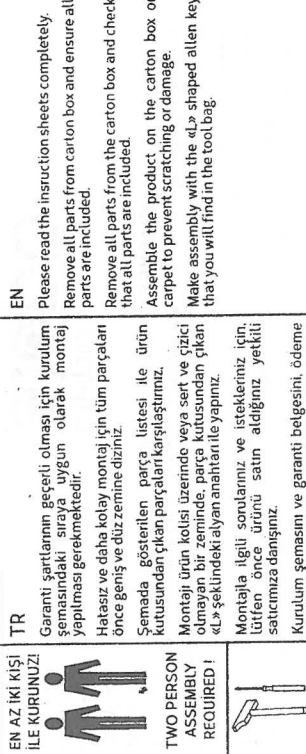
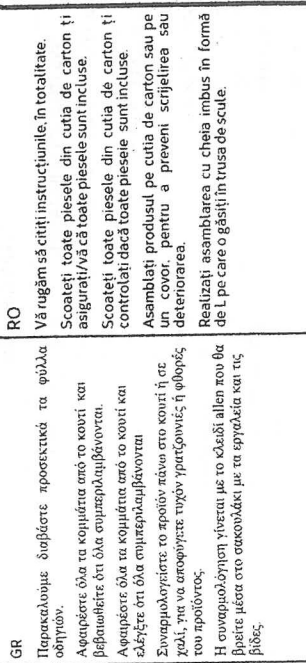
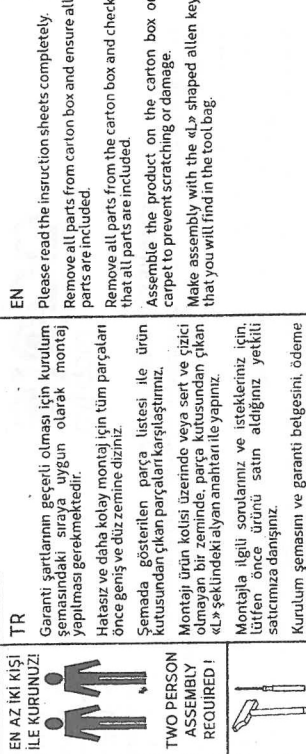
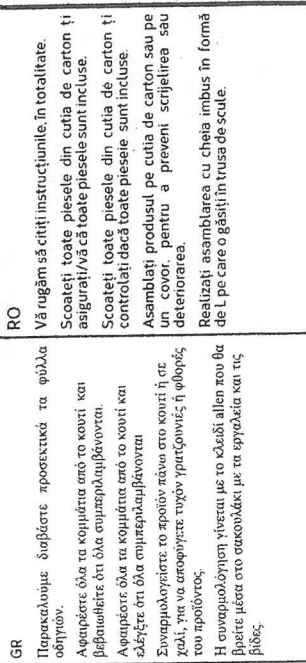
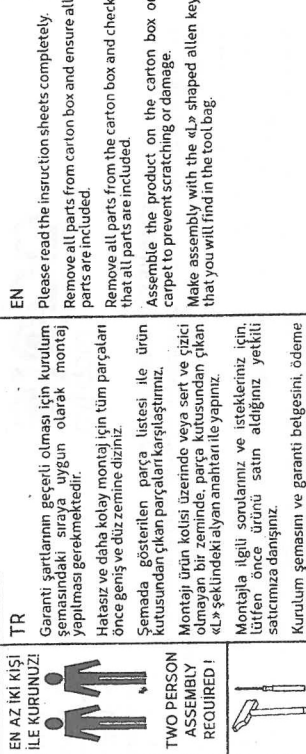
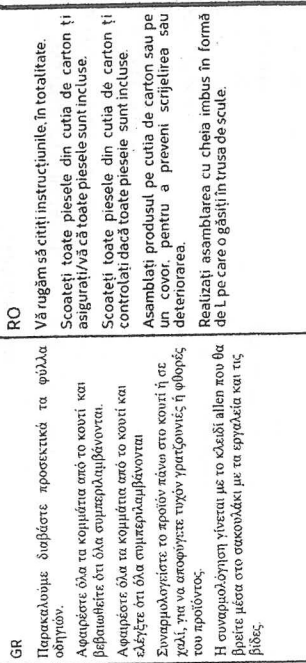
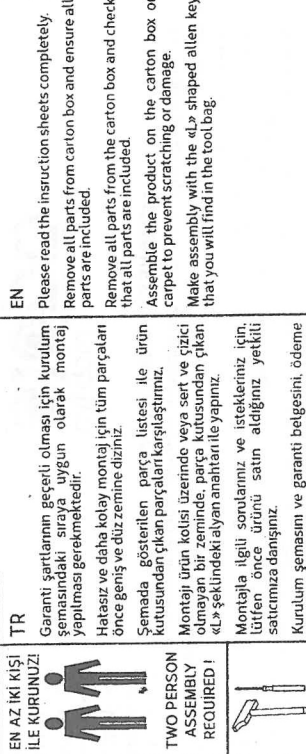
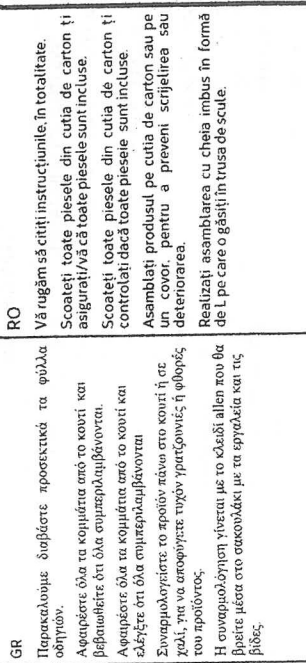
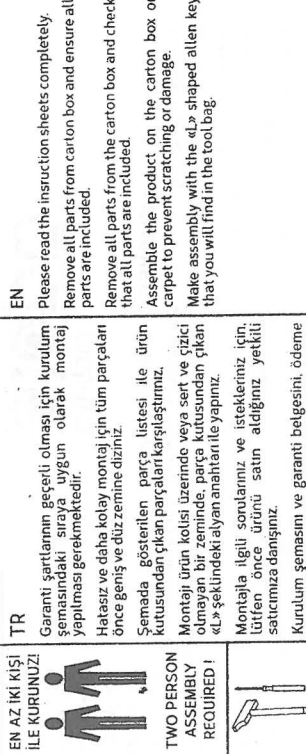
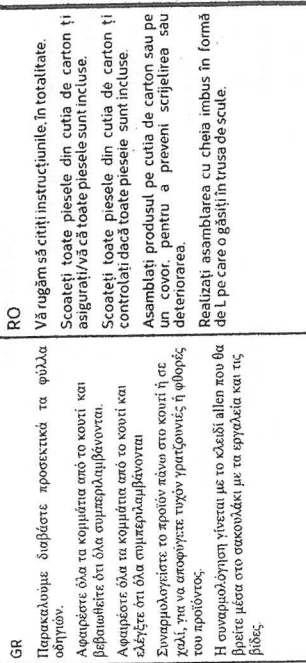
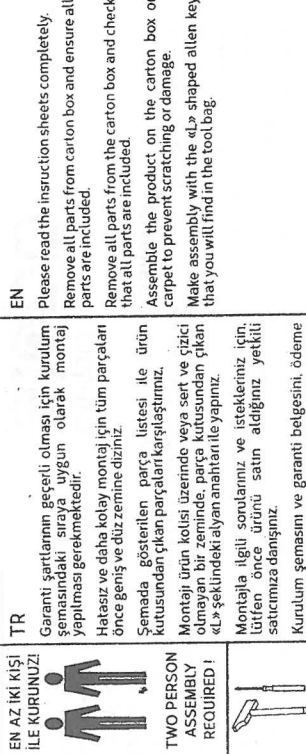
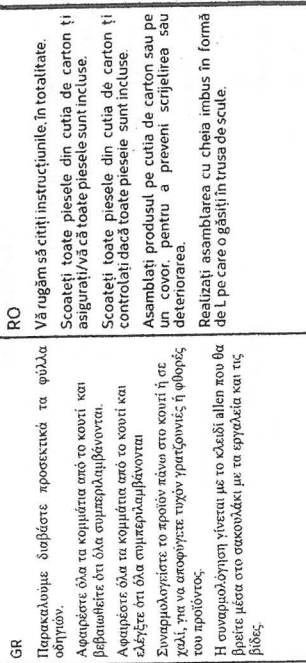
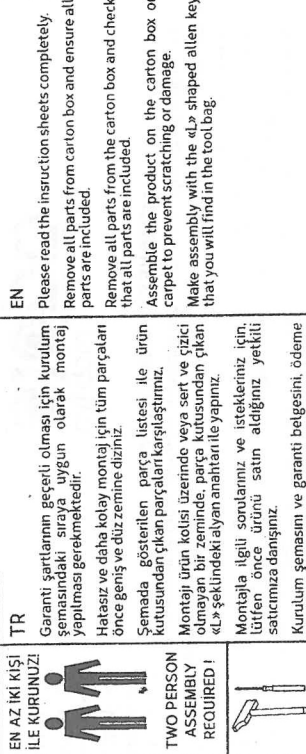
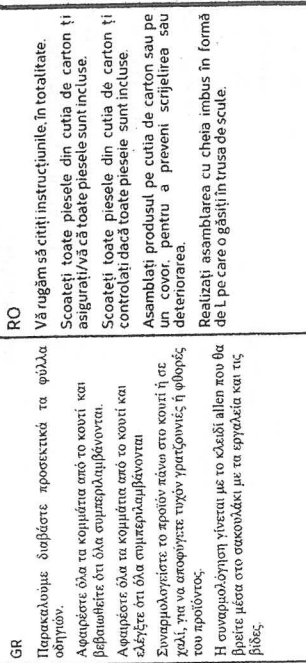
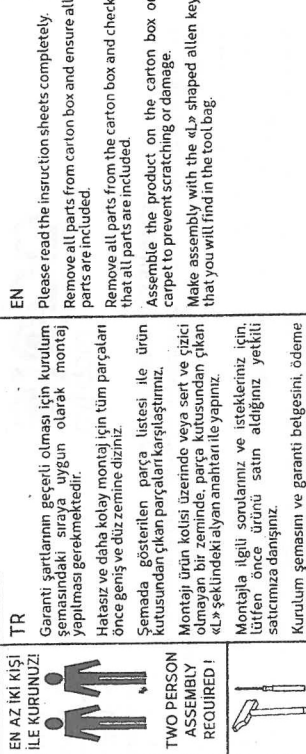
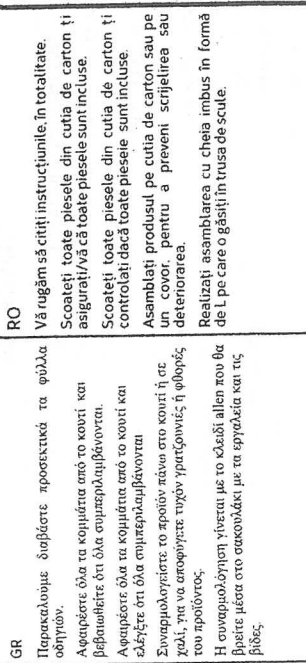
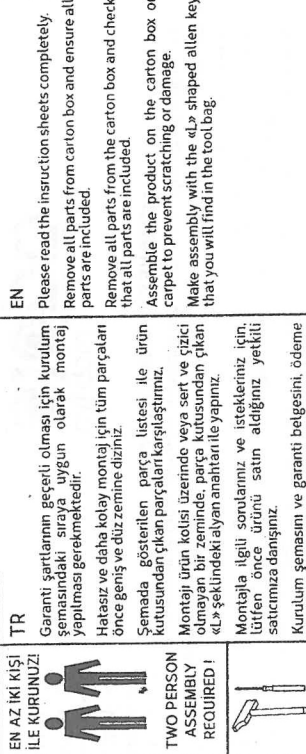
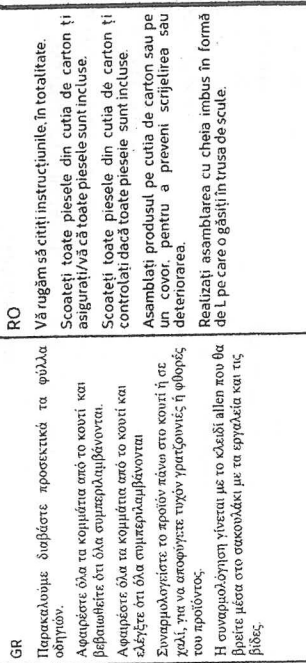
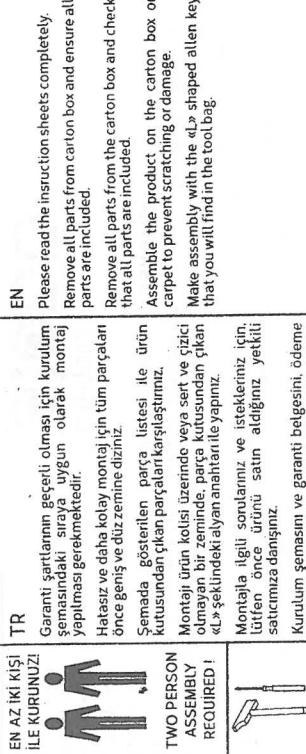
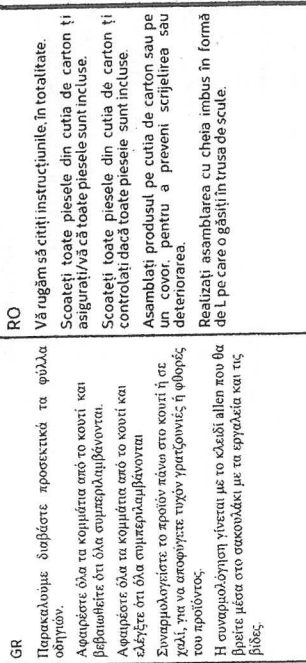
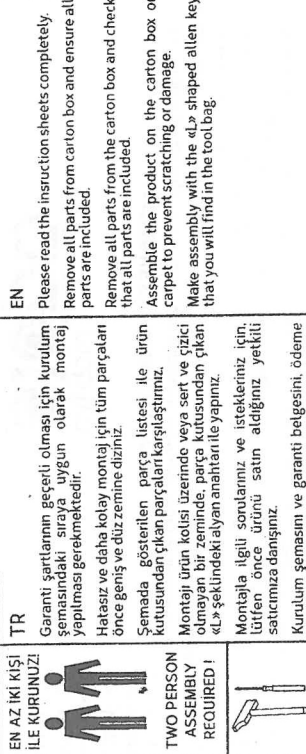
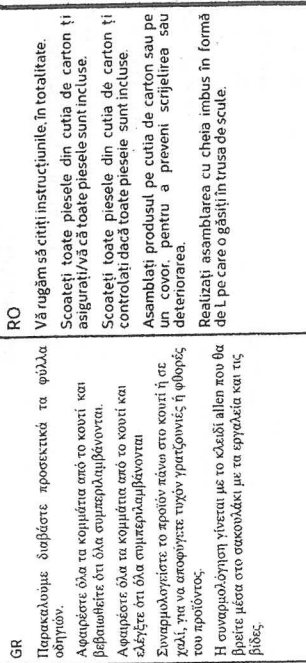
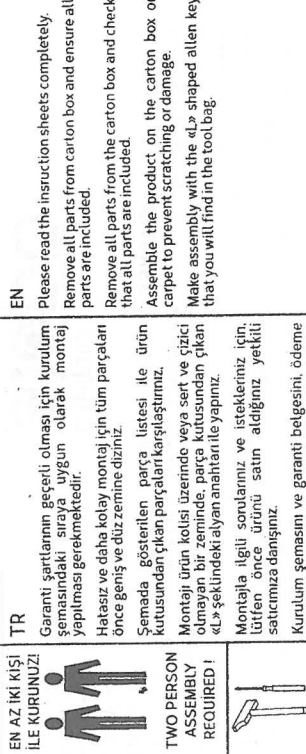
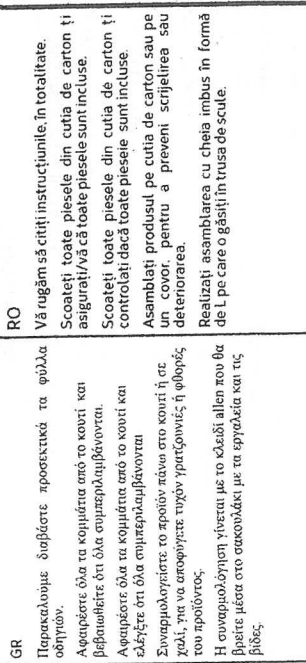
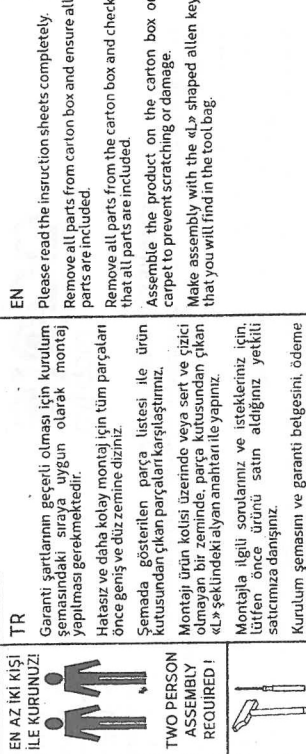
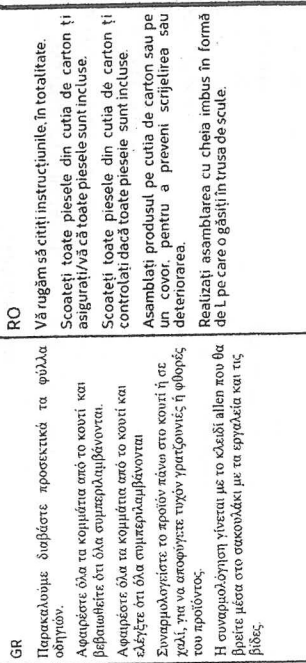
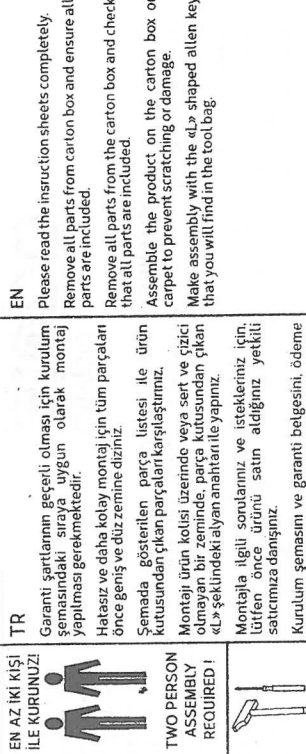
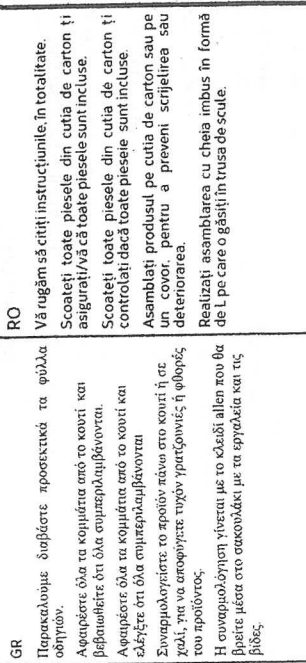
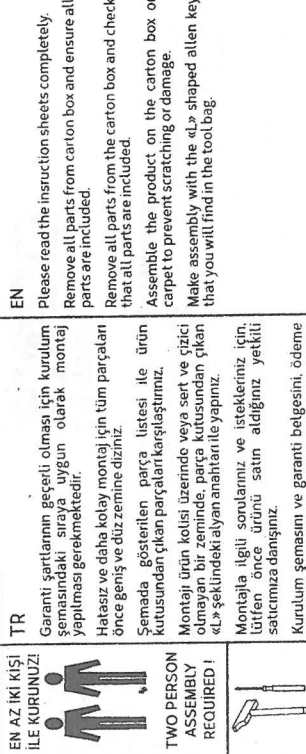
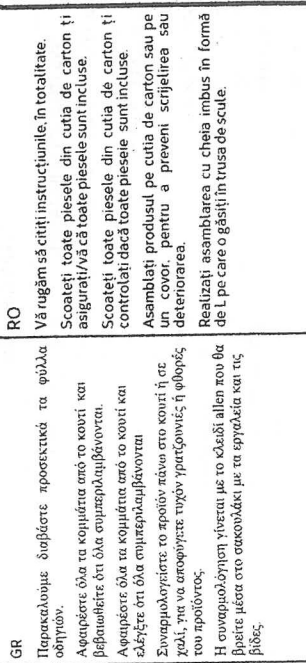
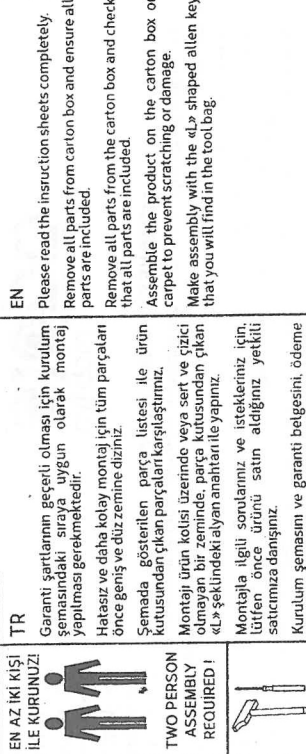
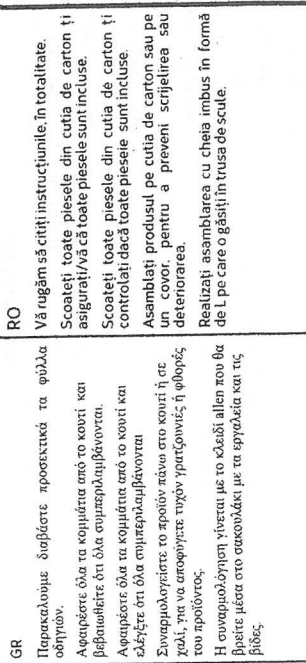
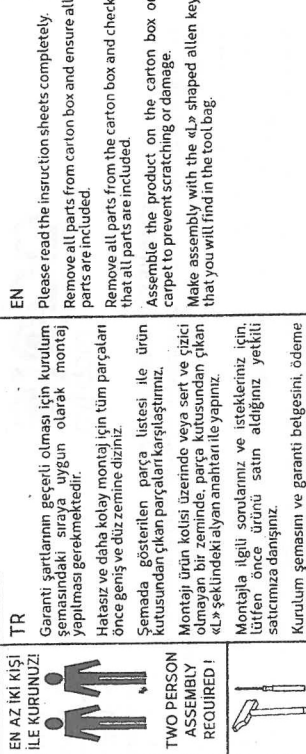
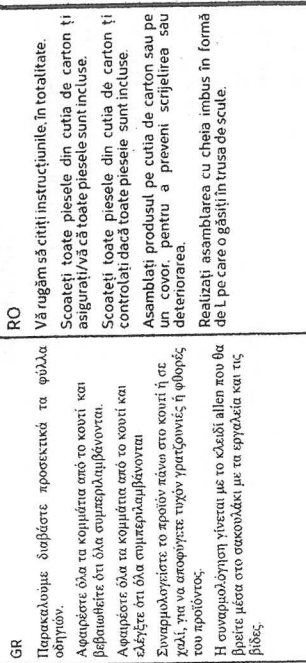
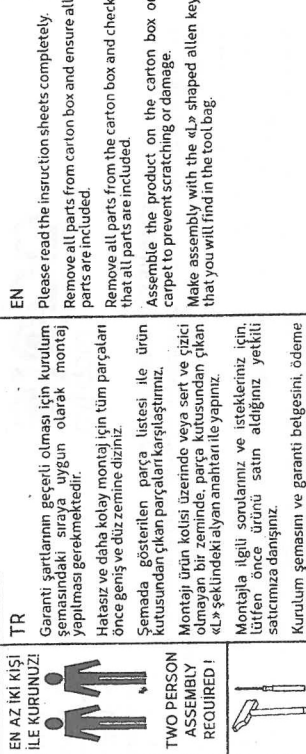
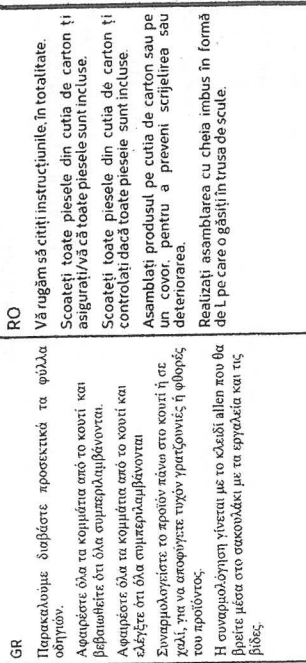
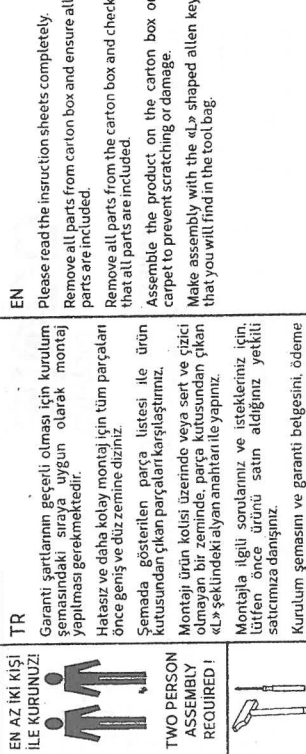
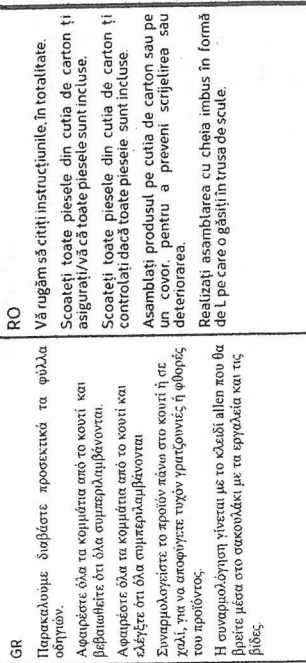
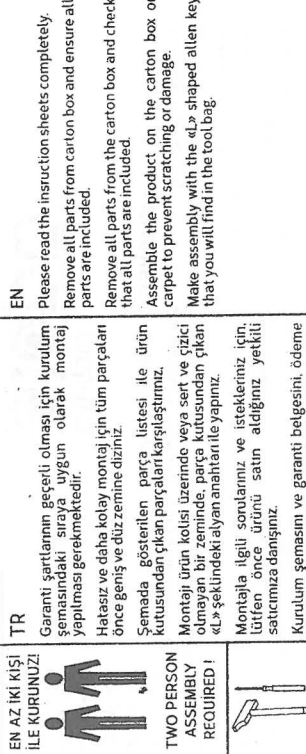
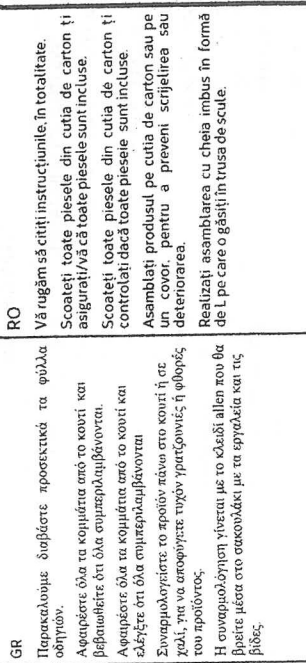
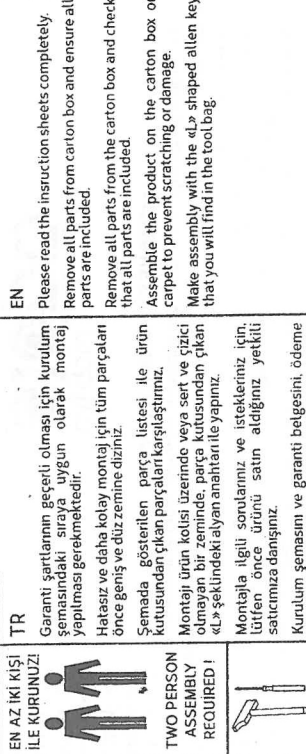
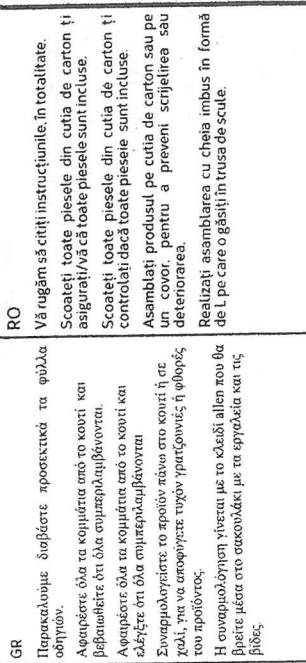
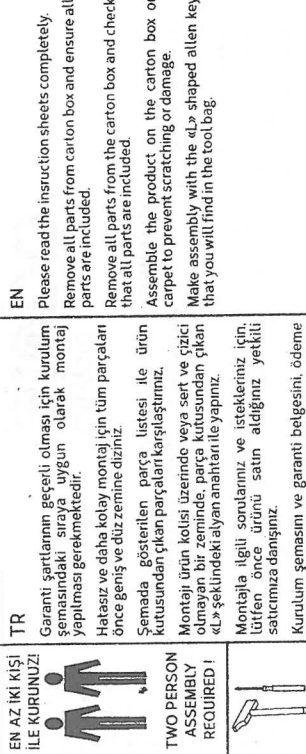
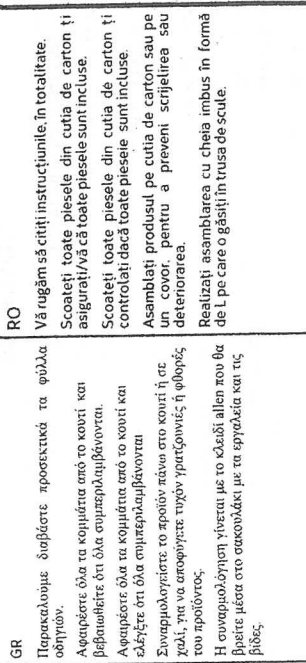
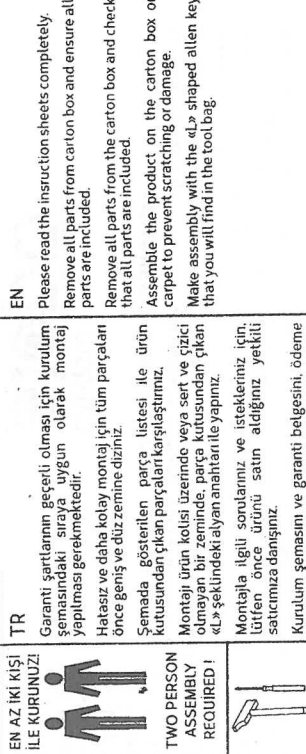
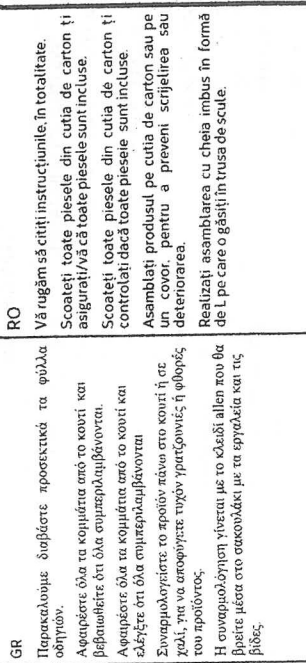
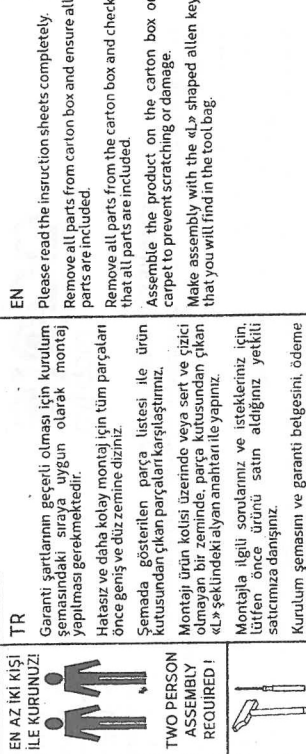
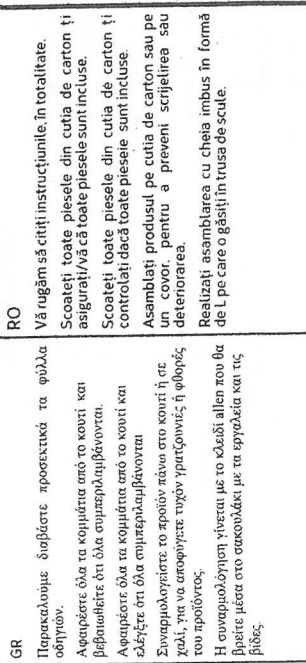
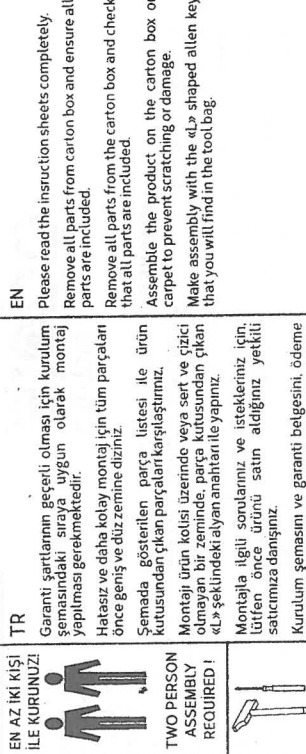
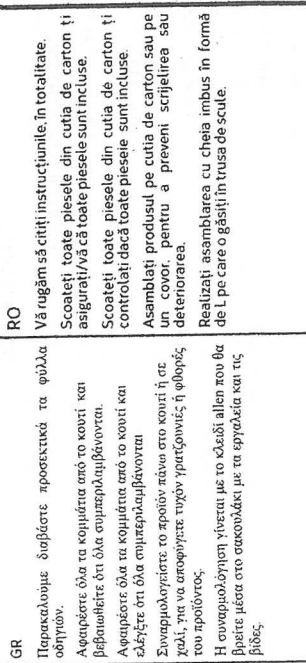
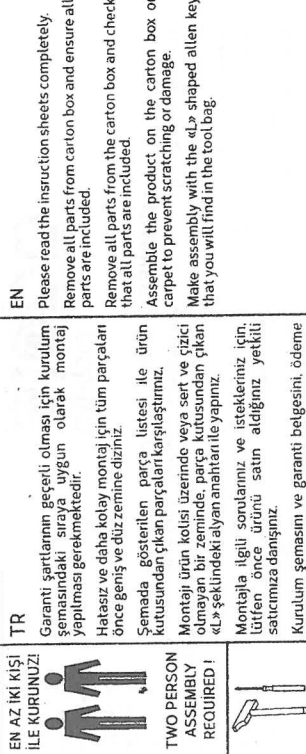
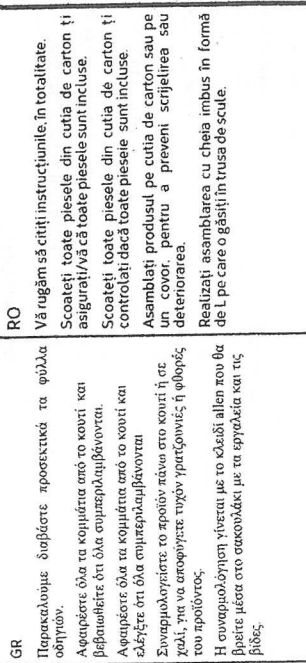
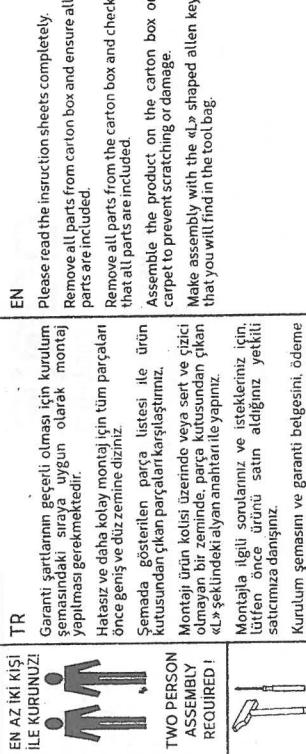
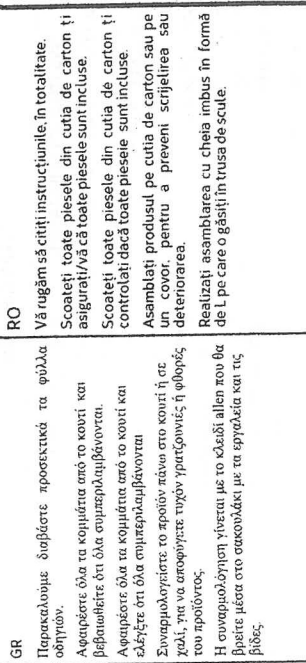
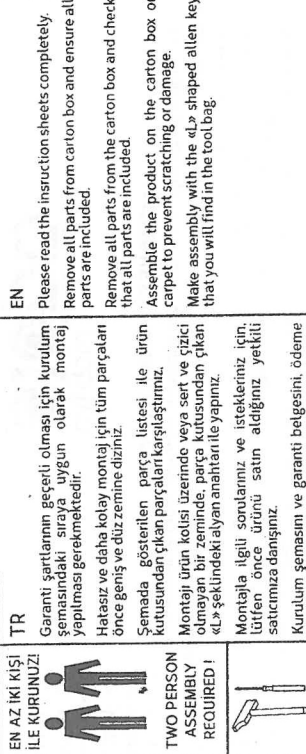
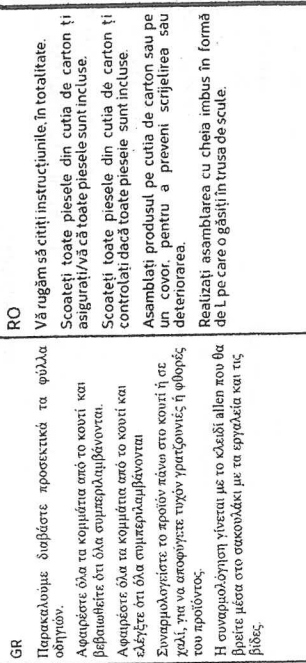
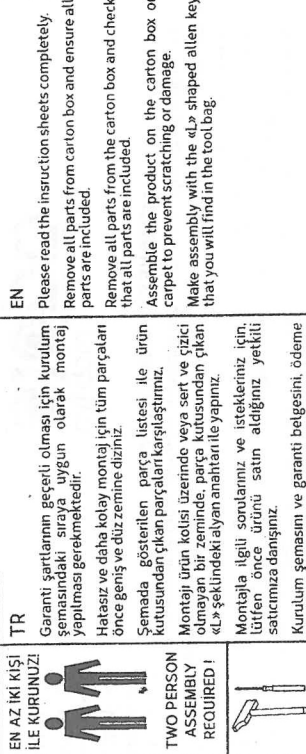
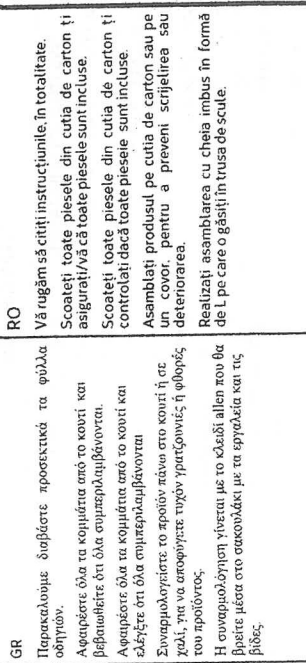
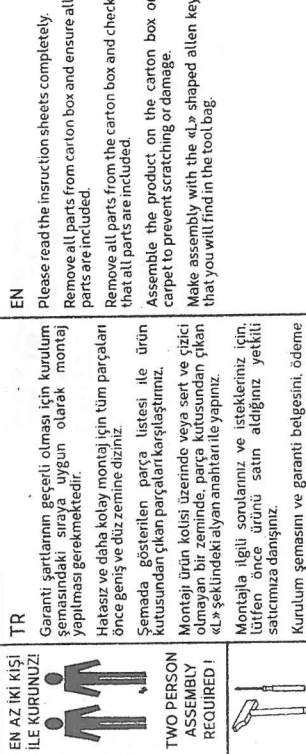
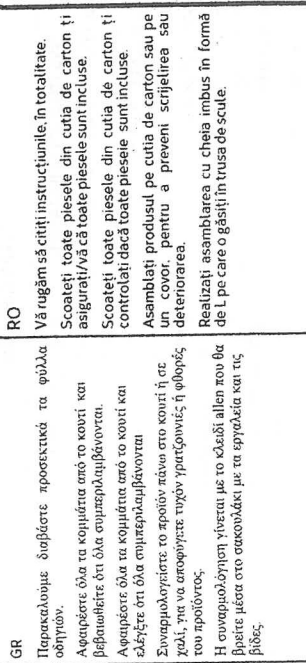
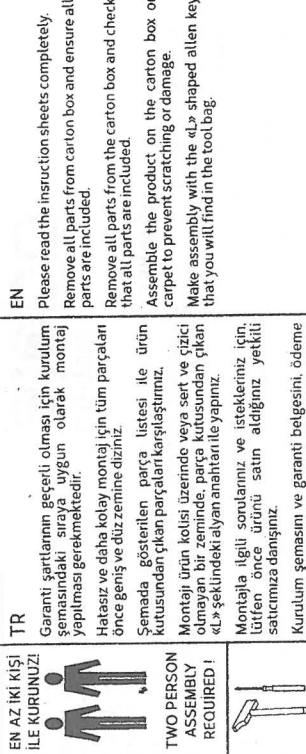
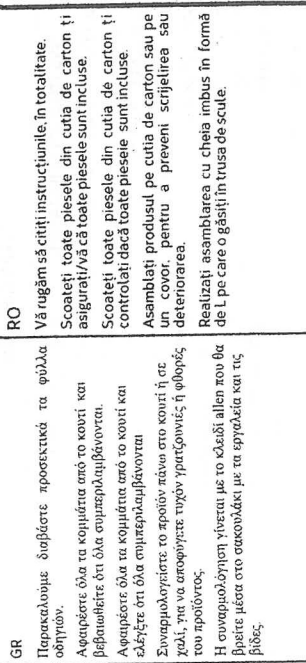
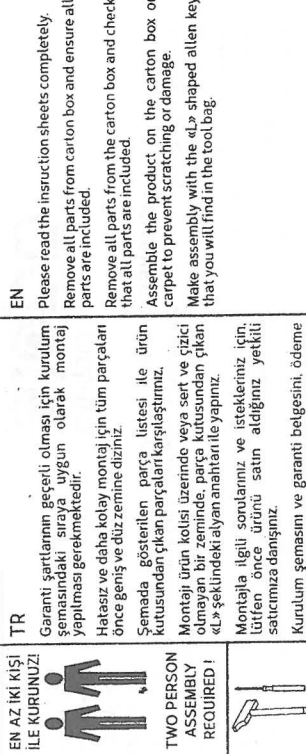
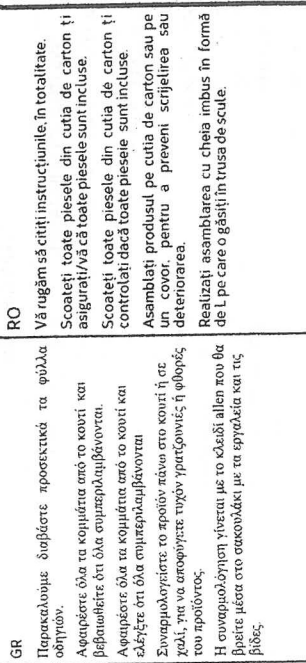
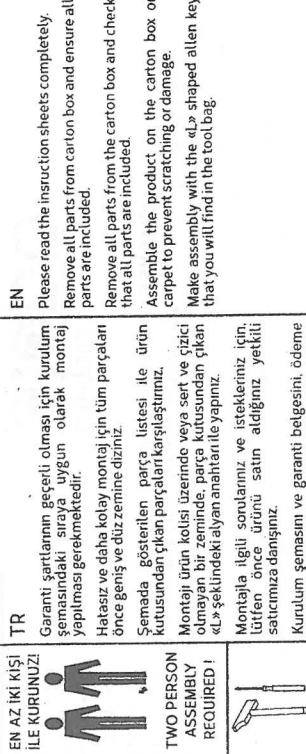
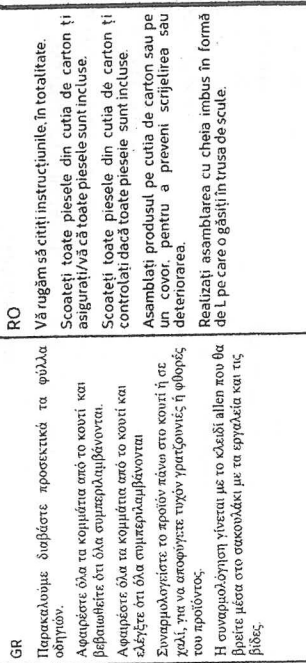
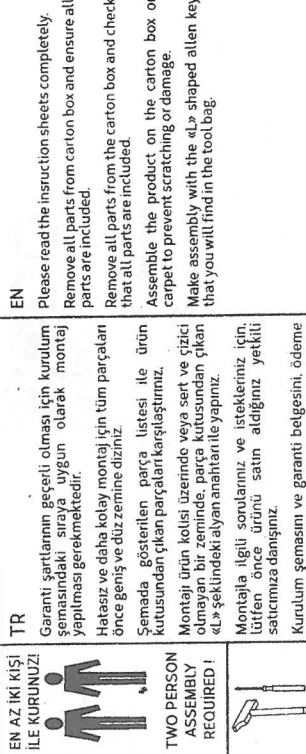
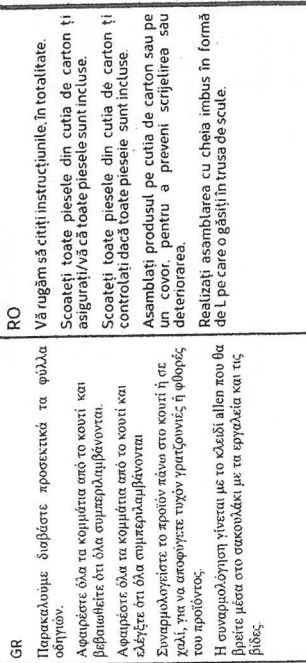
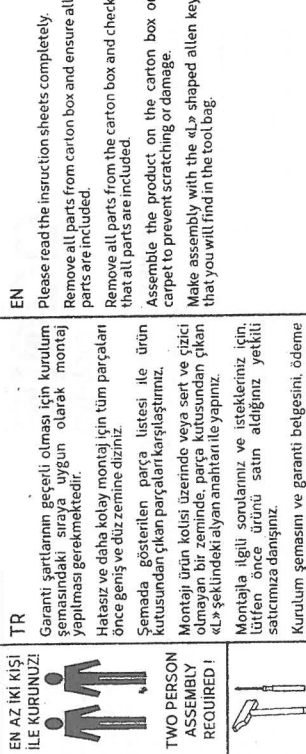
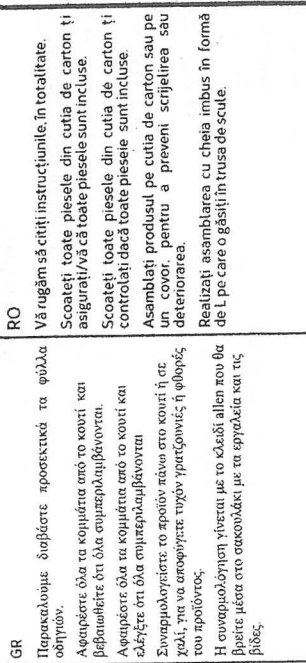
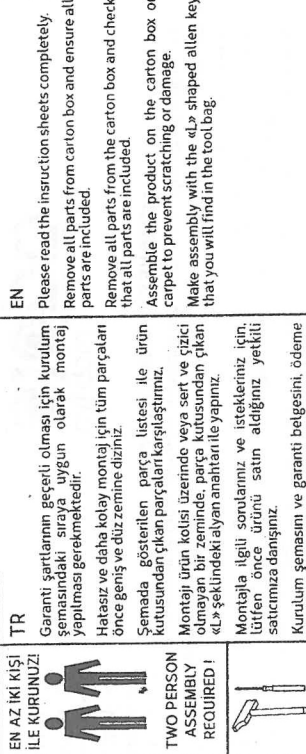
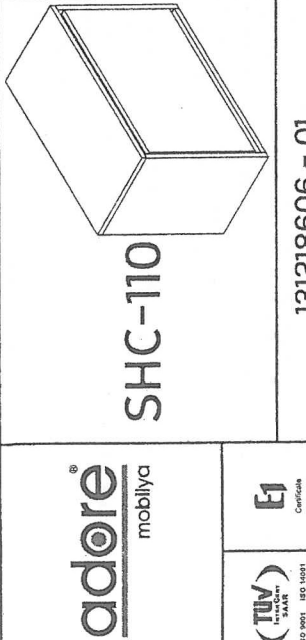



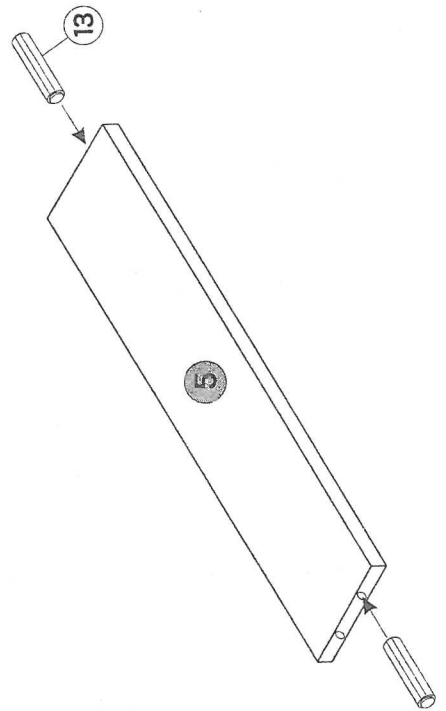
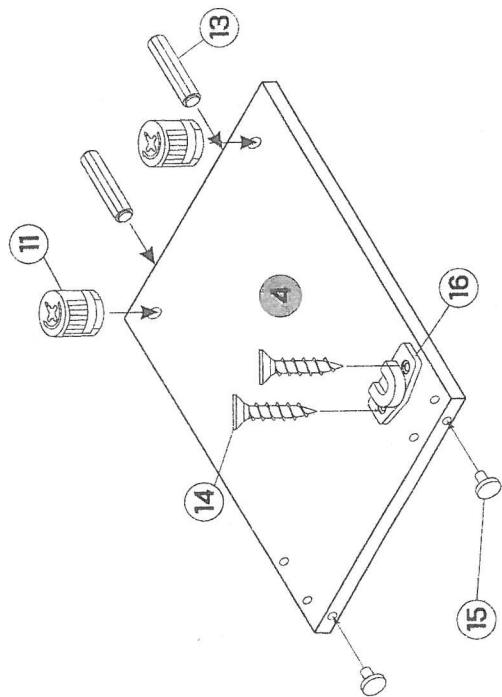
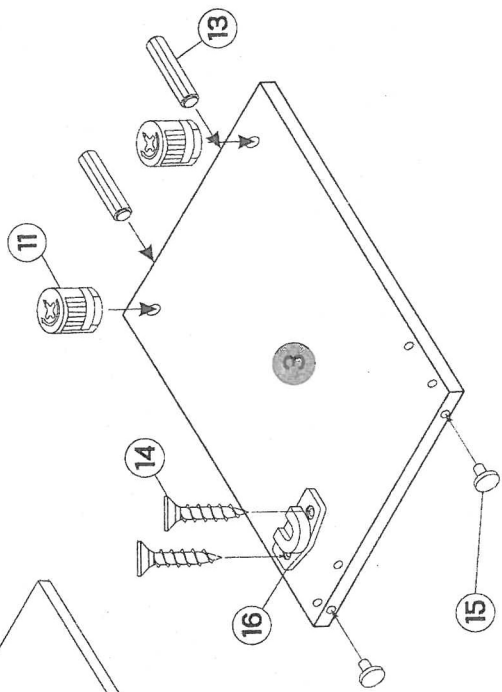
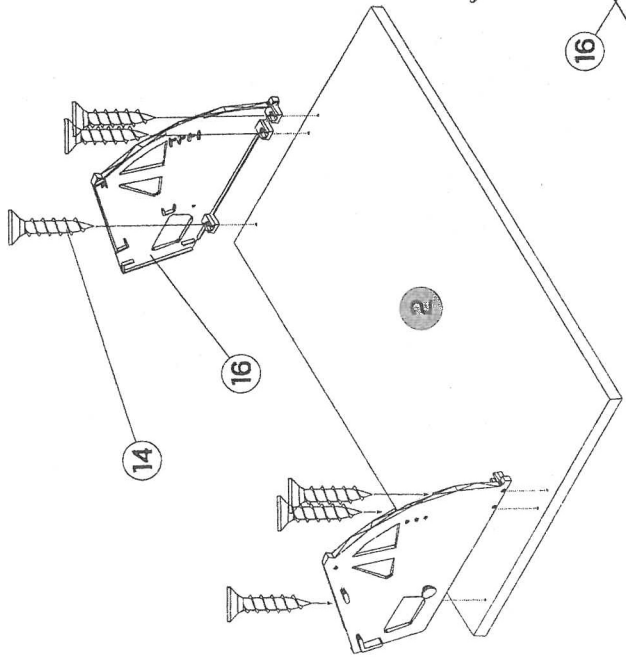
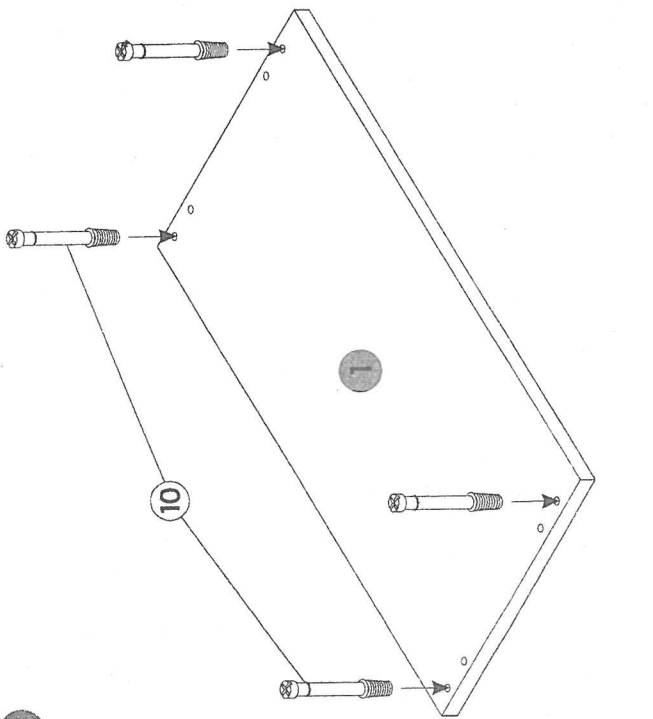

A

