

034-000094

<p>TPGR-42 QC:080319068 - 04 by adore</p>		<p>EN AZ İKİ KİŞİ İLE KURUNUZU TWO PERSON ASSEMBLY REQUIRED !</p>	 Rev 00 03/04/2018	<p>TR: Garanti şartlarının geçerli olması için kurulum çantasındaki sıraya uygun olarak montaj yapılması gerekmektedir. Hassas ve dikkatli montaj için tüm parçaların önce gömülmesi ve düz zemine dökülmesi. Şemada gösterilen parça listesi ile ürün kutusundan çıkan parçaları karşılayınız. Montajı ürün kolisi üzerinde veya sert ve eşiz olmayan bir zeminde, parça kutusundan çıkan 4x4 şeklindeki ölçüm anahtarını kullanarak yapınız. Montajla ilgili sorularınız ve istekleriniz için, lütfen önce ürünü satın aldığınız yetkili satıcımıza danışınız. Kurulum çantasının ve garanti belgesinin, ödeme evraklarımla birlikte saklayınız</p>	<p>EN: Please read the instruction sheets completely. Remove all parts from carton box and ensure all parts are included. Remove all parts from the carton box and check that all parts are included. Assemble the product on the carton box or carpet to prevent scratching or damage. Make assembly with the 4x4 shaped allen key that you will find in the tool bag.</p>	<p>GR: Παρακαλούμε διαβάστε προσεκτικά τα φύλλα οδηγιών. Αφαιρέστε όλα τα κομμάτια από το κορτί και βεβαιωθείτε ότι όλα συμπεριλαμβάνονται. Αφαιρέστε όλα τα κομμάτια από το κορτί και ελέγξτε ότι όλα συμπεριλαμβάνονται. Συνελευρώστε το προϊόν πάνω στο κορτί ή σε γόμα, για να αποφευχете τυχόν γρατζουνιές ή φθορές του προϊόντος. Η συναρμολόγηση γίνεται με το τεταράγωνο αλάν που θα βρείτε μέσα στο σακούλακι με τα εργαλεία και τις βίδες.</p>	<p>RO: Vă rugăm să citiți instrucțiunile în totalitate. Scoateți toate piesele din cutia de carton și asigurați-vă că toate piesele sunt incluse. Scoateți toate piesele din cutia de carton și controlați dacă toate piesele sunt incluse. Asamblați produsul pe cutia de carton sau pe un cover, pentru a preveni scrijelirea sau deteriorarea. Realizați asamblarea cu cheia imbus în formă de L pe care o găsiți în trusa de scule.</p>
<p>1</p> <p>1x</p>	<p>2</p> <p>1x</p>	<p>3</p> <p>1x</p>	<p>4</p> <p>1x</p>	<p>5</p> <p>1x</p>	<p>6</p> <p>1x</p>	<p>7</p> <p>2x</p>	
<p>8</p> <p>2x</p>	<p>9</p> <p>2x</p>	<p>10</p> <p>2x</p>	<p>11</p> <p>2x</p>	<p>12</p> <p>1x</p>	<p>13</p> <p>1x</p>	<p>14</p> <p>1x</p>	
<p>15</p> <p>1x</p>	<p>16</p> <p>1x</p>	<p>17</p> <p>1x</p>	<p>18</p> <p>1x</p>	<p>19</p> <p>1x</p>	<p>20</p> <p>1x</p>	<p>21</p> <p>1x</p>	
<p>22</p> <p>1x</p>	<p>23</p> <p>24x</p>	<p>24</p> <p>4x</p>	<p>25</p> <p>36x</p>	<p>26</p> <p>12x</p>	<p>27</p> <p>8x</p>	<p>28</p> <p>16 mm</p>	
<p>29</p> <p>4x</p>	<p>30</p> <p>30 mm</p>	<p>31</p> <p>40x</p>	<p>32</p> <p>4x</p>	<p>33</p> <p>6x</p>	<p>34</p> <p>12x</p>	<p>35</p> <p>4x</p>	
<p>36</p> <p>6x</p>	<p>37</p> <p>5x</p>	<p>38</p> <p>5x</p>	<p>39</p> <p>5x</p>	<p>40</p> <p>4x</p>	<p>41</p> <p>2x</p>	<p>42</p> <p>2x</p>	

- 1 Sağ - 1 Sol
- 1 Right - 1 Left
- 1 δεξιά - 1 αριστερά
- 1 dreapta - 1 stânga

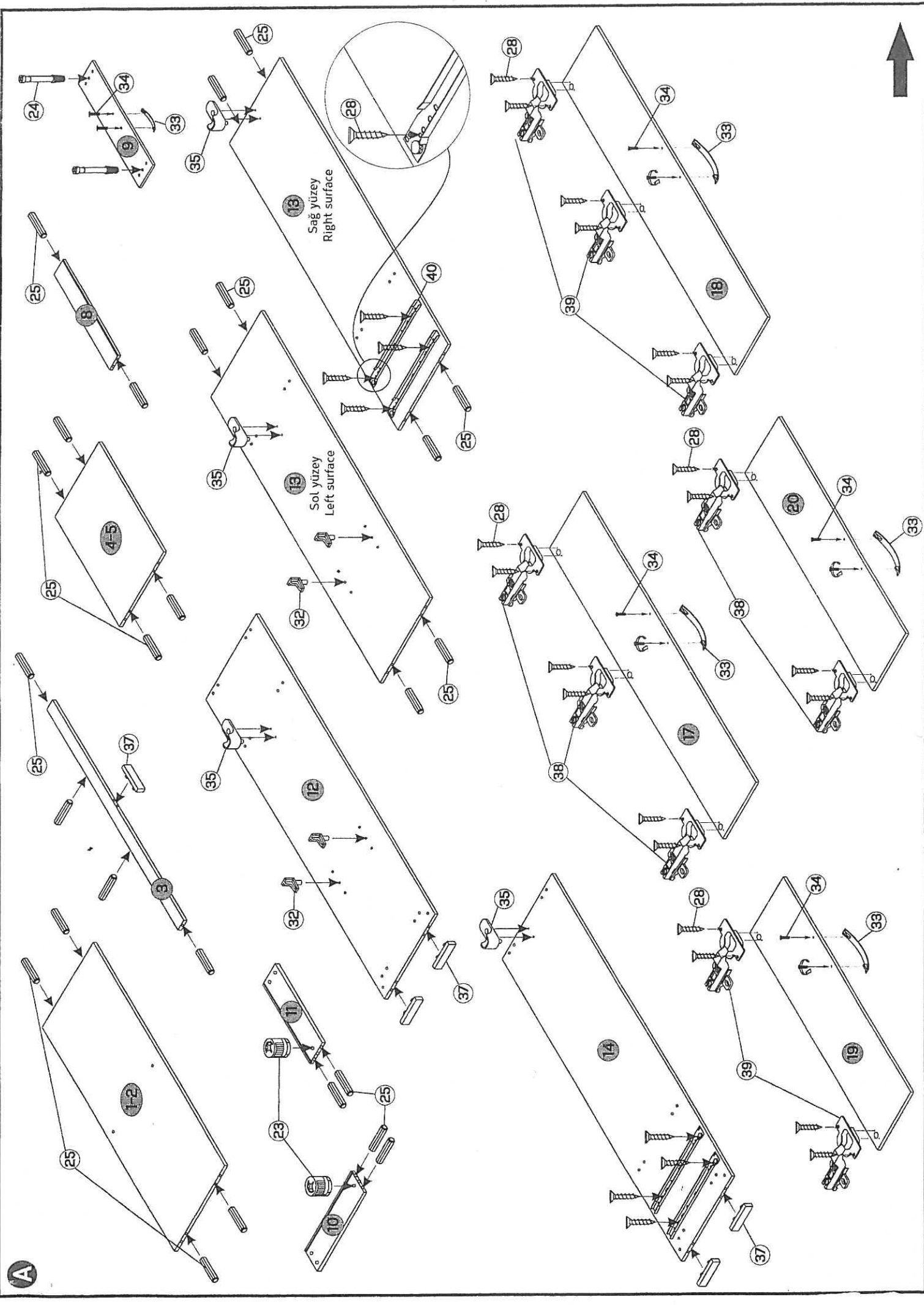

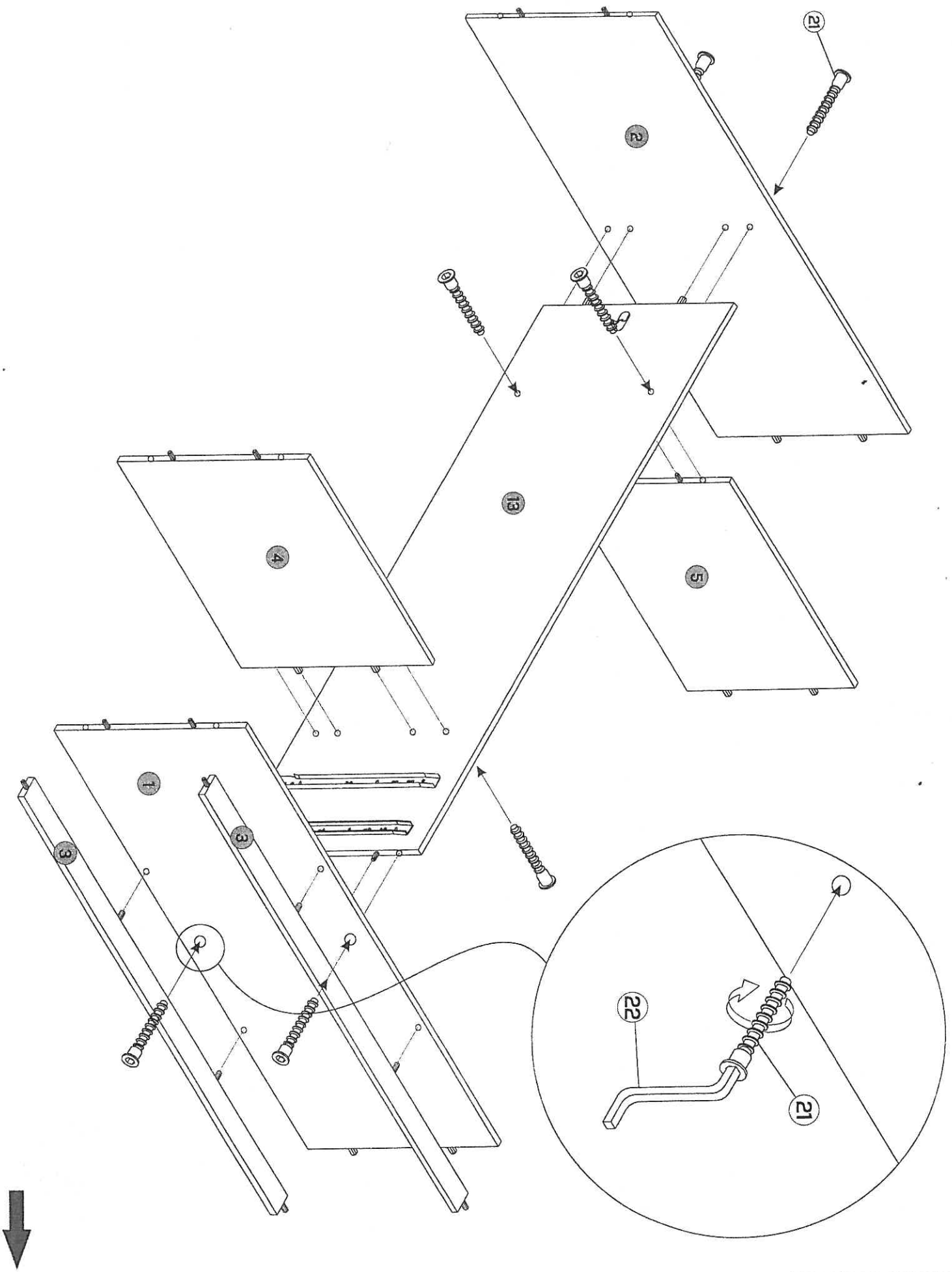

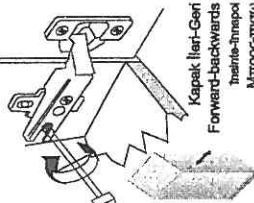
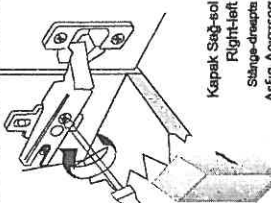
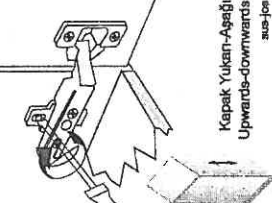
<p>Καπάκ lieri-Geni Forward-backwards Παλίνα-μεσολά Μπροσώ-πίσω</p> 	<p>DOOR ADJUSTMENT ΚΑΠΑΚ ΑΥΑΡΙ</p>
<p>Καπάκ Sağ-sol Right-left Sığma-şeyma Δεξιά-Αριστερά</p> 	<p>Καπάκ Yukarı-Aşağı Upwards-downwards Yukarı-Asağı Προς τα πάνω-προς τα κάτω</p> 

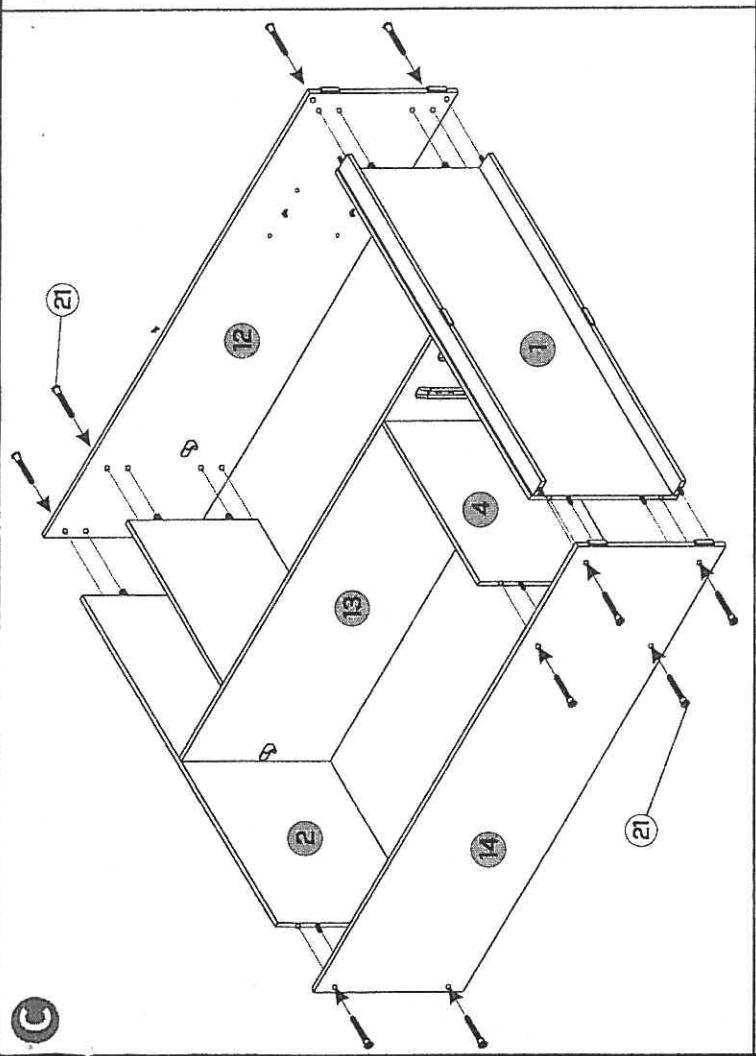
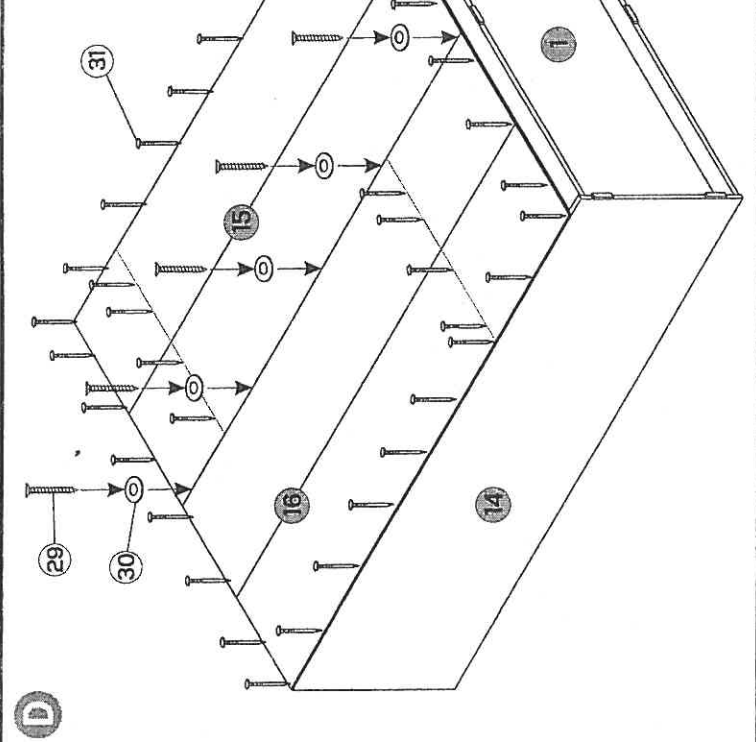
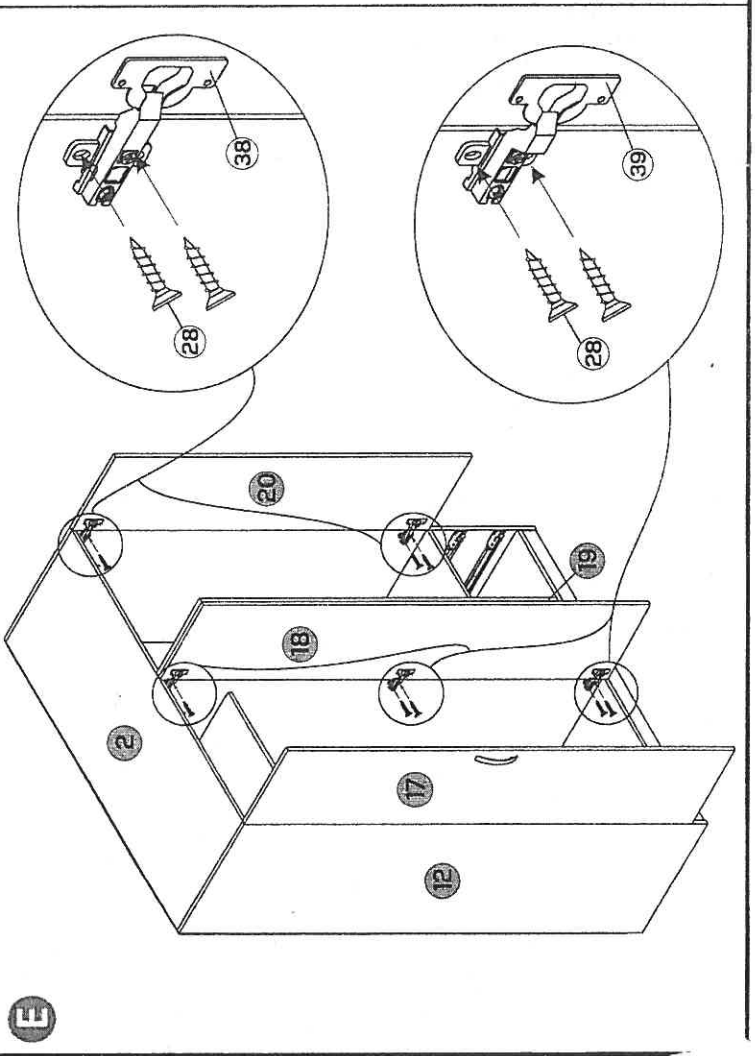
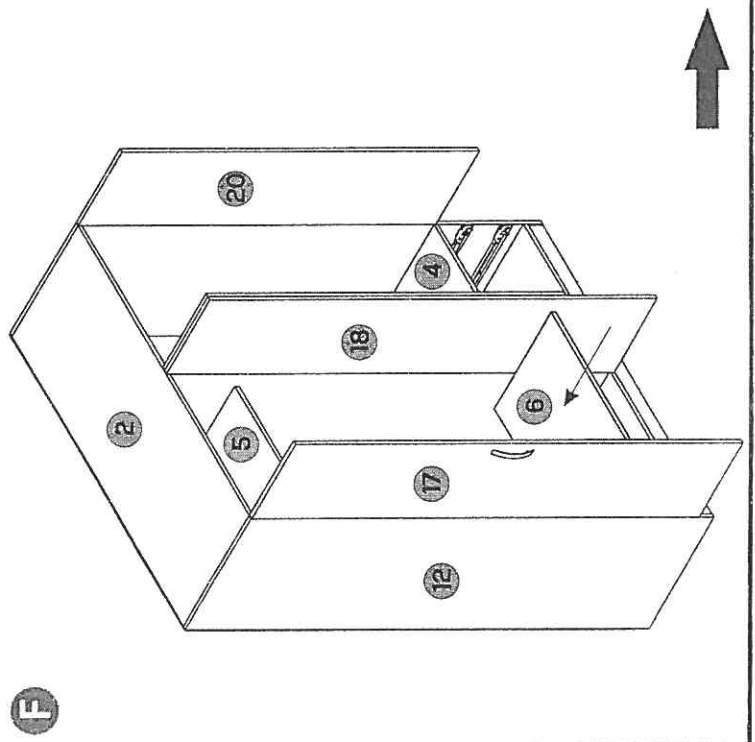

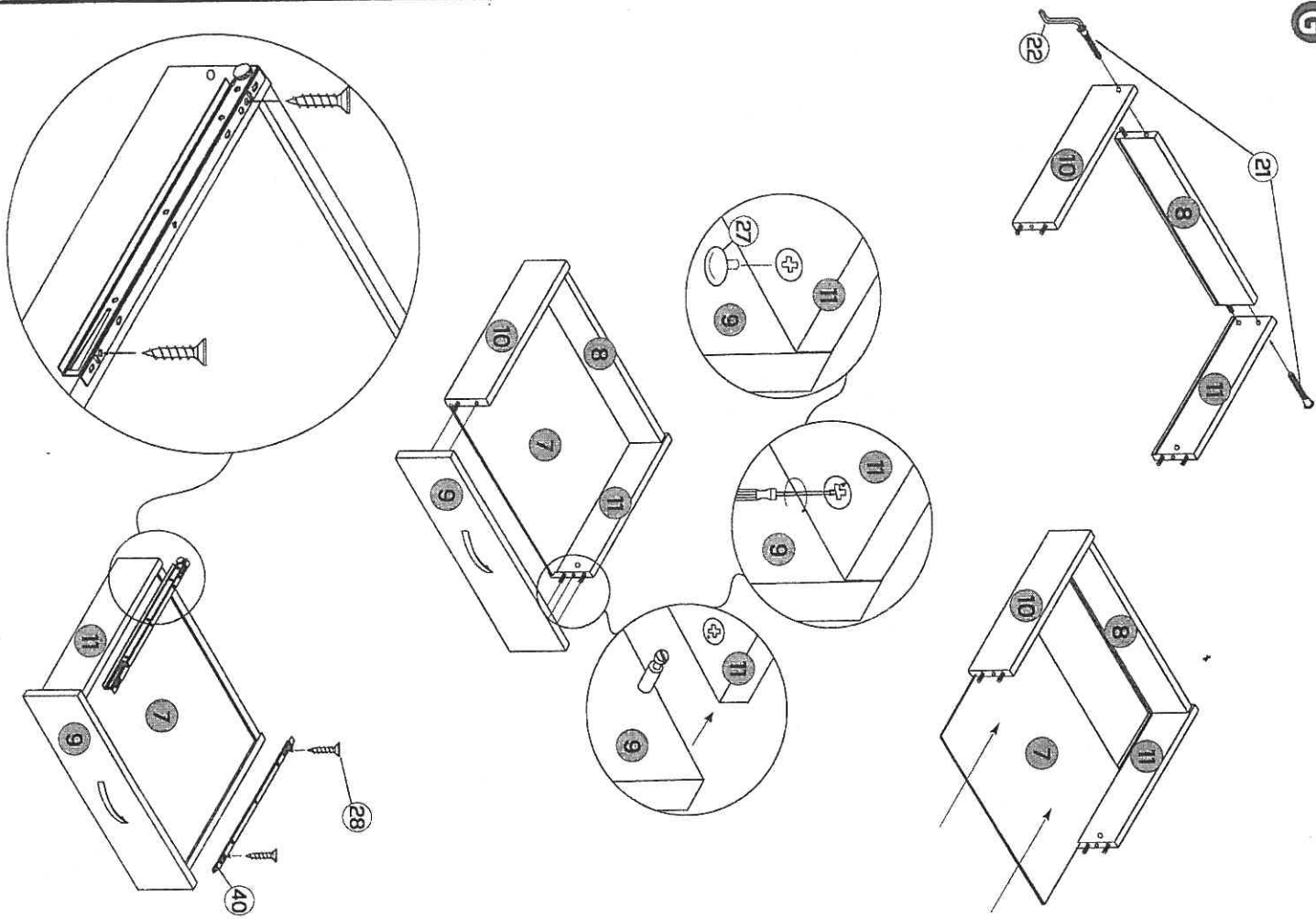
G**H**