

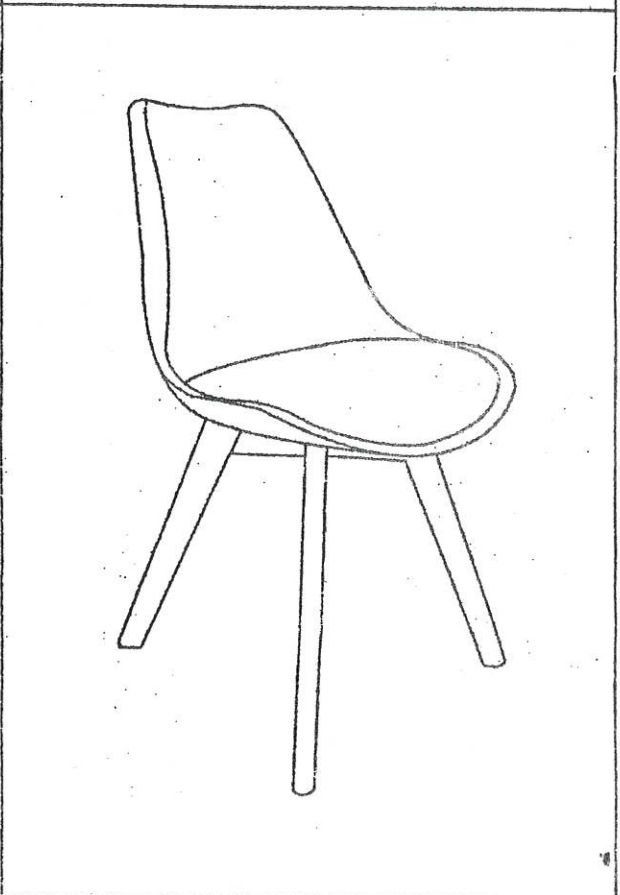

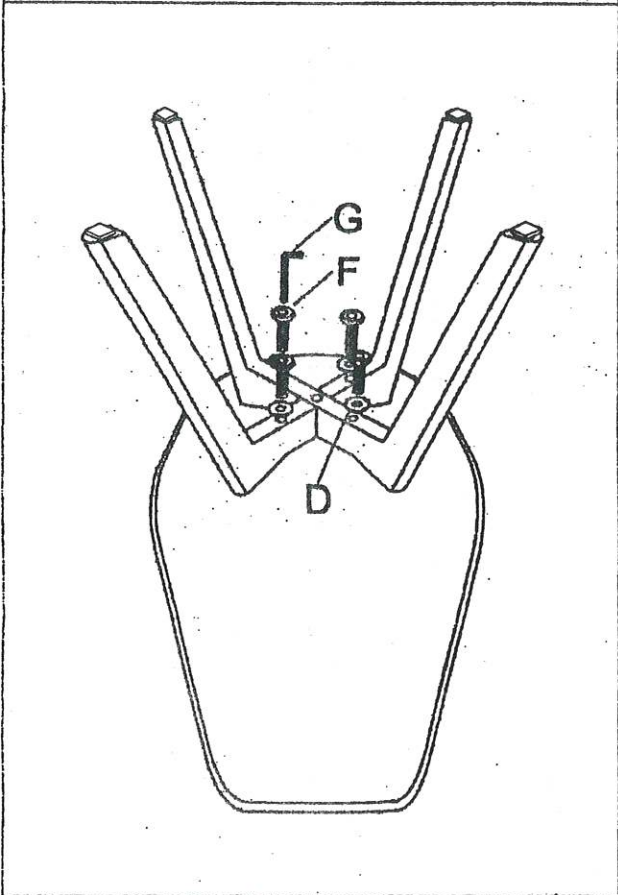

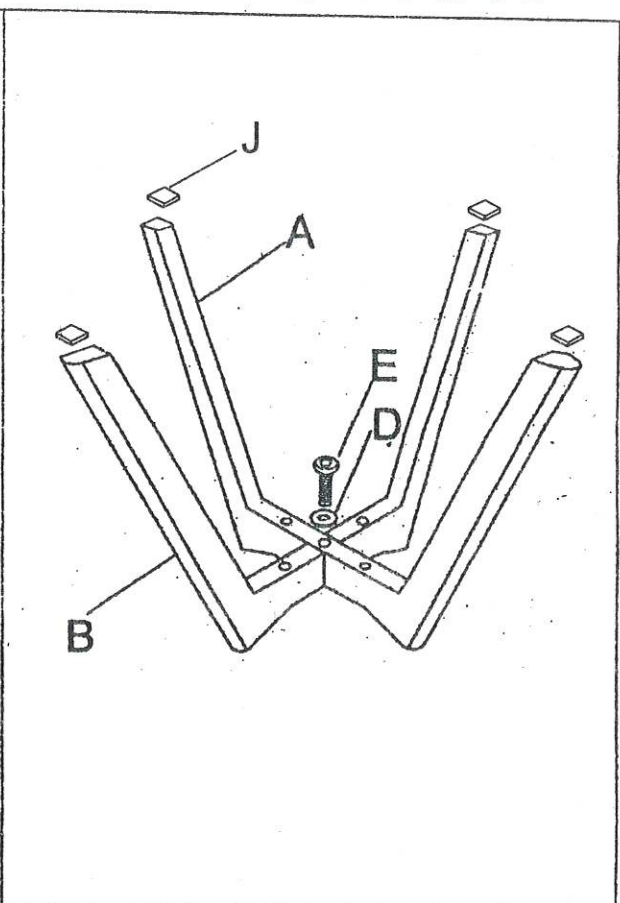

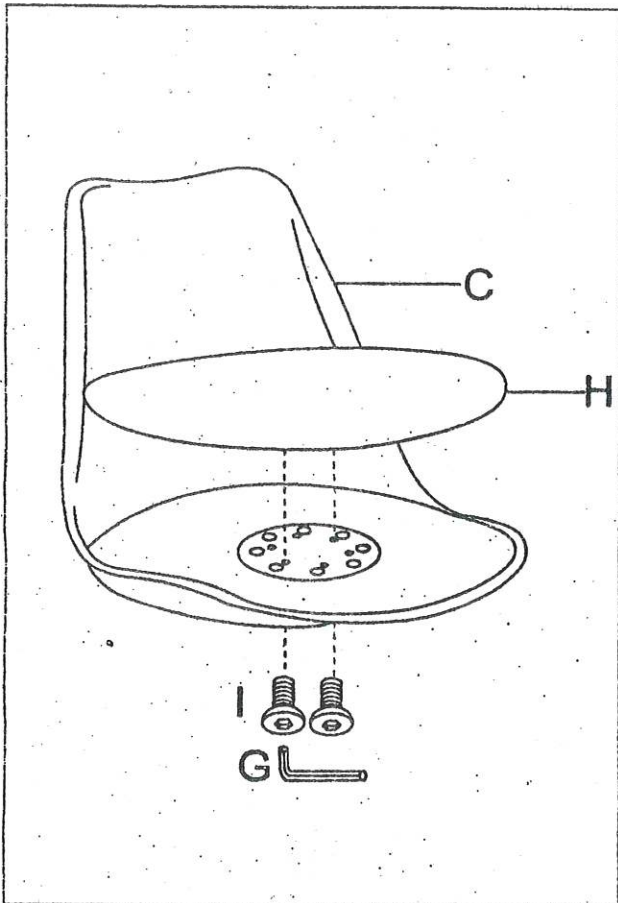



# ASSEMBLY INSTRUCTION



									
Ax1	Bx1	Cx1	Dx5	Ex1	Fx4	Gx1	Hx1	Ix2	Jx4