















**IMPORTANT NOTE:**

- ※PLACE ALL PARTS ON A CLEAN AND SMOOTH SURFACE SUCH AS A RUG OR CARPET TO AVOID THE PARTS FROM BEING SCRATCHED.
- ※KINDLY FOLLOW THE ASSEMBLY INSTRUCTIONS STEP BY STEP.
- ※DO NOT TIGHTEN ALL SCREWS UNTIL THE BED IS FULLY SET-UP.

<b>PARTS LIST &amp; HARDWARE LIST</b>					
<b>1:HEAD BOARD</b> 1pc 	<b>2:FOOT BOARD</b> 1PC 	<b>3: SIDE RAIL</b> 2PCS 	<b>4:SLAT 12PC</b> 	<b>5: SINGLE PLASTIC CAP</b> 24PCS 	<b>6 : LEG 4PCS</b> 
<b>7:SLAT 1PC</b> 					
<b>A:BOLT 4PCS</b>  M8X75mm	<b>B:BOLT 8PCS</b>  M8X30mm	<b>C:SPRING WASHER</b> 12PCS 	<b>D:FLAT WASHER</b> 12PCS 	<b>E:ALLEN KEY</b> 1PC  M8	<b>F:Screw 2PCS</b>  M4x30
<b>G:ALLEN KEY</b> 1PC 					



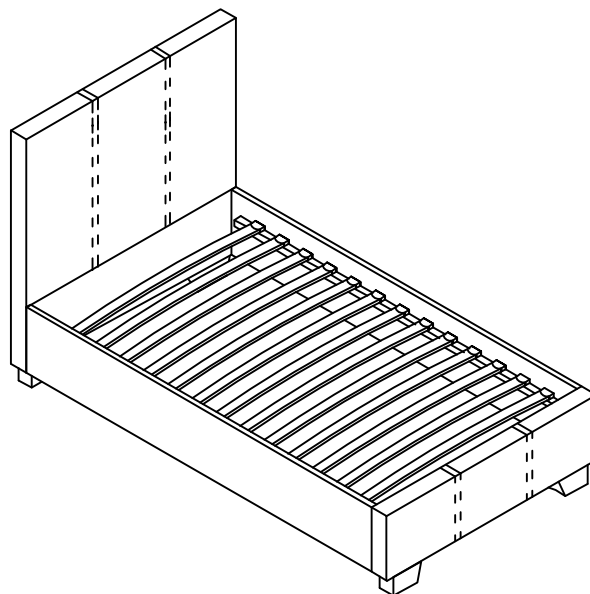
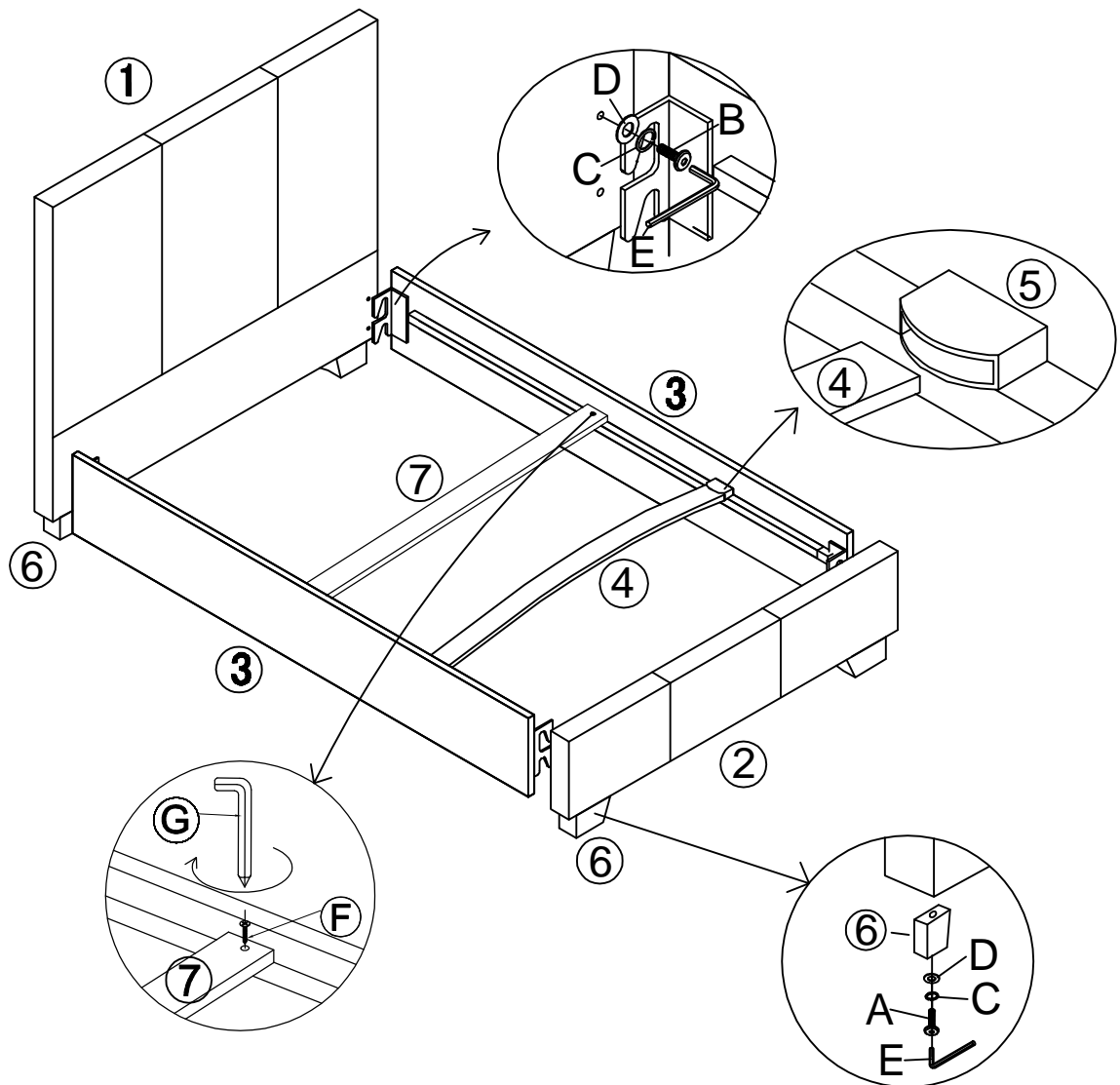

- STEP 1 :FIXING LEGS TO HEADBOARD AND FOOTBOARD;  
 STEP 2 :FIXING SUPPORT LEGS TO CENTR SUPPORT BAR;  
 STEP 3 :FIXING SIDE RAILS AND CENTRE SUPPORT BAR TO HEADBOARD AND FOOTBOARD;  
 STEP 4 :ONCE SLAT ASSEMBLED POSITION PEGS ON THE BASE OF CAPS INTO CORRESPONDING HOLES ON THE SIDE RAILS AND CENTRAL SUPPORT BAR,THEN CAREFULLY PRESS DOMN ON CAPS TO SECURE.